

TABLE OF CONTENTS

DURACAST™

DuraCast™ Plain Round Tapered Columns	4
DuraCast™ Plain Round Tapered Fluted Columns.....	6
DuraCast™ Round Tapered Split Columns	7
DuraCast™ Round Fluted Tapered Split Columns.....	9
DuraCast™ Cap and Base/Plinth Sets	10
DuraCast™ Decorative Capitals for Round Tapered Columns.....	11
DuraCast™ Ornamental Capitals for Round Columns	13
DuraCast™ Plain Round Non-Tapered Columns	14
DuraCast™ Round Split Non-Tapered Columns	15
DuraCast™ Square Non-Tapered Columns.....	17
DuraCast™ Square Split Non-Tapered Columns.....	18
DuraCast™ Recessed Panel Non-Tapered Columns	19
DuraCast™ Craftsman Columns	20
DuraCast™ Craftsman Split Columns	20
DuraCast™ Square Panel and Neck Moulding.....	21
DuraCast™ Square Ornamental Capitals.....	22
DuraCast™ Caps and Bases for Square Columns.....	22

DURALITE®

DuraLite® Square Columns	24
DuraLite® Tuscan Capitals and Bases for Square Columns.....	24
DuraLite® Round Columns.....	24
DuraLite® Recessed Panel Columns.....	25
DuraLite® Panel Divider Kits for Square Non-Tapered Recessed Panel Columns	25
DuraLite® Panel Insert Kits for Square Non-Tapered Recessed Panel Columns.....	25

PVC SQUARE COLUMN

Plain (2 - L - Shaped Halves) PVC Square Columns.....	26
Recessed (2 - L - Shaped Halves) Square PVC Columns	26
Raised Panel (2 - L - Shaped Halves) Square PVC Columns	26
Plain Craftsman (2 - L - Shaped Halves) PVC Columns.....	27
Recessed Panel Craftsman (2 - L - Shaped Halves) PVC Columns.....	27
Raised Panel Craftsman (2 - L - Shaped Halves) PVC Columns	27
Recessed Panel Pedestal (2 - L - Shaped Halves) PVC Columns	27
Raised Panel Pedestal (2 - L - Shaped Halves) PVC Columns.....	27
Caps and Bases for Square Columns.....	28

WRAP N' SNAP COLUMN WRAPS

Wrap N' Snap® Column Wraps.....	29
Wrap N' Snap® Cap and Base Trim Kits.....	29
Wrap N' Snap® Accessories.....	29

WOOD COLUMN

Round Wood Columns List Pricing	31
Ornamental Capitals for Round Wood List Pricing	32
Cap and Base Options for Round Wood Columns List Pricing	33

ALUMINUM COLUMN

Round White Fluted Aluminum Column.....	34
Square White Fluted Aluminum Column	34
Square Textured Legend Aluminum Column.....	34
Square Plain Textured Elite Aluminum Column.....	35
Square White Heritage Aluminum Column	35
Round & Square Aluminum Split Cap & Base Set.....	35
Square Fluted Vinyl Post Wrap	35

PERGOLA

Reinforced PVC Pergolas	36
Fiberglass Pergolas	36
Economy Hollow-Body Vinyl Pergolas	36

PORCH POST

Synthetic Porch and Lamp Posts.....	37
Wood Porch Posts	38

BALUSTRADE

6" Balustrade System	39
7" Balustrade System	40
12" Balustrade System.....	41
Curved Balustrade System.....	42

PVC

PVC Porch Ceiling.....	43
DuraLast PVC Railing	44

ACCESSORIES

Brackets	45
Medallions	46
Displays	47
Terms and Conditions	48
Warranty Information.....	49

DuraCast™ Fiberglass Columns

DuraCast™ Columns Quick Facts

Key Features:

- Round or Square
- Architecturally Correct Proportions
- Plain or Fluted Shaft
- Durable
- Low Maintenance
- Decay Resistant
- Load Bearing
- Decorative Capitals Available
- Limited Lifetime Warranty

About DuraCast™ Columns:

- DuraCast™ Fiberglass Columns are manufactured using a spun cast technology and are composed of Fiberglass Reinforced Polymers (FRP).
- Available in the following designs: Round or Square; Tapered or Non-Tapered; Plain or Fluted.
- The DuraCast™ Fiberglass Column Shaft runs floor to ceiling and the cap and base/plinth slide around the shaft. (Example: An 8" x 8' Fiberglass Column Shaft measures 8') See Illustration 1.
- All Cap and Base/Plinth sets as well as Decorative Capitals are sold separately from the column shaft.
- DuraCast™ Fiberglass Columns are load bearing provided that they are not split.
- DuraCast™ Fiberglass Columns can be cut to any overall length. Unless using an ornamental capital always cut from the bottom end of the shaft.
- DuraCast™ Round Tapered Fiberglass Columns have a true architectural taper. The bottom 1/3 is non-tapered and the top 2/3 is tapered. Cutting in the taper will require a base modification.
- DuraCast™ Round Tapered Fiberglass Columns used with Decorative Capitals must be "cut at the bead" in order for the Decorative Capital to fit properly.

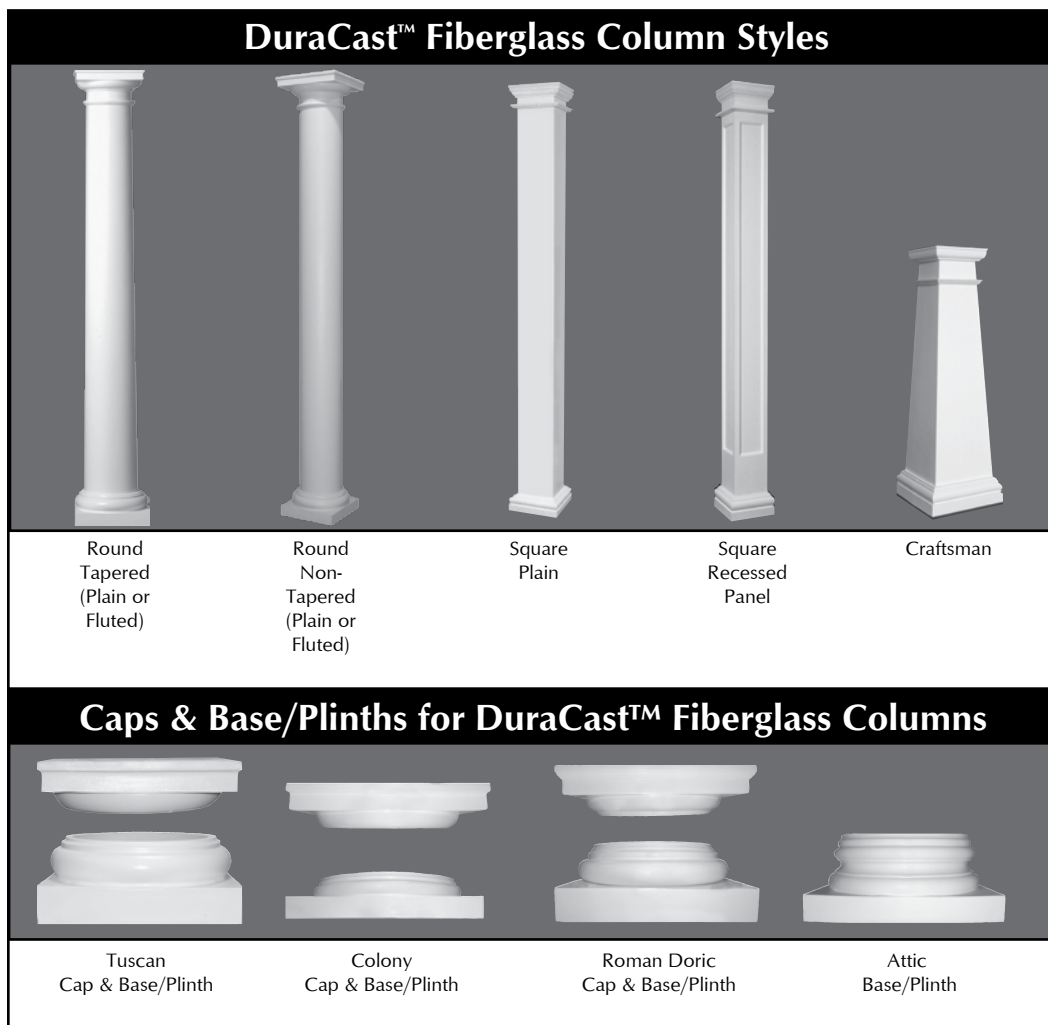

Options & Ordering Tips:

- Tuscan Cap and Base/Plinths are the standard components for DuraCast™ Fiberglass Columns. Additional styles are also available and are sold separately (See pages 10-11).
- All Caps and Base/Plinths for DuraCast™ Fiberglass Columns are non-vented.
- Numerous sizes and styles of Decorative Capitals are available for DuraCast™ Fiberglass Columns and are sold separately (See pages 12-13).
- DuraCast™ Round Tapered Small Stock Fiberglass Columns (6" x 8' - 12" x 12'; 14" x 8' - 14" x 10') are boxed individually and collared. Caps and base/plinths are boxed separately from the column shaft in a cap and base/plinth set box.
- DuraCast™ Round Tapered Large Fiberglass Columns (12" x 14', 12" x 16' and all sizes above 14" x 10') are crated (Price includes crating). Caps and base/plinths are boxed separately from the column shaft in a cap and base/plinth set box.
- Available in a Plain or Fluted Round Shaft (certain styles). DuraCast™ Round Fluted Fiberglass Columns can also be ordered with adjustable flutes.
- DuraCast™ Fiberglass Columns can be split in half for reassembly, pilaster application, or a variety of other plan types.

Illustration 1

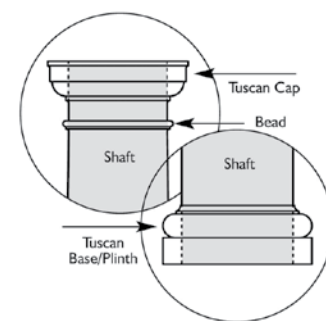

DuraCast™ Round Balcony Bracket Kit



The Dixie-Pacific® Balcony Installation Bracket Kit includes 3 brackets and all required hardware. The bracket fits 20"- 36" Plain Round DuraCast™ Columns and will secure a second story balcony to a DuraCast™ Column. One kit is required for each column.



Item #	Price
17121	\$571.00

DuraCast™ Round Tapered Standard Rack and Pallet Quantities

Product Size	Rack Quantity	Product Stacked	Pallet Quantity Boxed
	(Individually Boxed)		
6" Round Fiberglass	36	6 Wide, 6 High	N/A
8" Round Fiberglass	25	5 Wide, 5 High	N/A
10" Round Fiberglass	16	4 Wide, 4 High	N/A
12" Round Fiberglass	9	3 Wide, 3 High	N/A
6" Tuscan Polyurethane Cap & Base/Plinth Set	N/A	N/A	60
8" Tuscan Polyurethane Cap & Base/Plinth Set	N/A	N/A	48
10" Tuscan Polyurethane Cap & Base/Plinth Set	N/A	N/A	36
12" Tuscan Polyurethane Cap & Base/Plinth Set	N/A	N/A	24
8" Tuscan (SIM) Cap & Base/Plinth Set	N/A	N/A	128
10" Tuscan (SIM) Cap & Base/Plinth Set	N/A	N/A	54
12" Tuscan (SIM) Cap & Base/Plinth Set	N/A	N/A	45







**Add to Shaft Only List Price.*

Fiberglass Column Installation Kit (Sold Separately)



To be used during installation to secure column shaft in place	Item #	Price
	17040	\$10.60
Each Kit Includes: (4) Brackets (2 top; 2 bottom) (10) 2" Stainless Screws (10) Tapcon Screws		

Plan Types for Split DuraCast™ Columns

Q* **C*** **D** **H*** **K***

Plan Types:

Columns can be split to the following plan types: C, D, Q, H, and K.

*Splitting columns to Plan Type C, Q, H, and K require an additional splitting charge.

DuraCast™ Fiberglass Columns

DuraCast™ Plain Round Tapered Columns

Bottom Diameter X Height	Plain Shaft		Cap & Base		Complete Column	Wt (lbs)	Per Pallet
	Price	Stock #	Price	Stock #	Shaft & C/B Plain		
6"x8'	\$165.90	70010608PL	\$40.50	7058060602	\$206.40	37	24
8"X5'6"	\$167.00	70010856PL	\$38.00	6058080802	\$205.00	45	25
8"X6'	\$168.60	70010806PL	\$38.00	6058080802	\$206.60	45	25
8"x8'	\$184.80	70010808PL	\$38.00	6058080802	\$222.80	65	25
8"x9'	\$207.90	70010809PL	\$38.00	6058080802	\$245.90	66	25
8"x10'	\$231.00	70010810PL	\$38.00	6058080802	\$269.00	73	25
10"X5'6"	\$194.30	70011056PL	\$51.00	6058101002	\$245.30	75	16
10"X6'	\$207.90	70011006PL	\$51.00	6058101002	\$258.90	75	16
10"x8'	\$219.50	70011008PL	\$51.00	6058101002	\$270.50	80	16
10"x9'	\$247.80	70011009PL	\$51.00	6058101002	\$298.80	88	16
10"x10'	\$276.20	70011010PL	\$51.00	6058101002	\$327.20	99	16
10"x12'	\$403.20	70011012PL	\$51.00	6058101002	\$454.20	122	12
12"x6'	\$272.60	70011206PL	\$65.00	6058121202	\$337.60	114	9
12"x8'	\$300.30	70011208PL	\$65.00	6058121202	\$365.30	114	9
12"x9'	\$342.30	70011209PL	\$65.00	6058121202	\$407.30	120	9
12"x10'	\$375.90	70011210PL	\$65.00	6058121202	\$440.90	134	9
12"x12'	\$536.60	70011212PL	\$65.00	6058121202	\$601.60	162	6
12"x14'	\$1,039.60	45210	\$78.30	40053	\$1,117.90	185	N/A
12"x16'	\$1,242.20	45230	\$78.30	40053	\$1,320.50	201	N/A
12"x18'	\$1,689.30	45250	\$78.30	40053	\$1,767.60	235	N/A
14"x8'	\$722.80	45270	\$213.40	7058141402	\$936.20	119	6
14"x9'	\$759.50	45274	\$213.40	7058141402	\$972.90	138	6
14"x10'	\$796.30	45290	\$213.40	7058141402	\$1,009.70	149	6
14"x12'	\$950.60	45310	\$213.40	7058141402	\$1,164.00	185	6
14"x14'	\$1,128.99	45330	\$213.40	7058141402	\$1,342.39	222	6
14"x16'	\$1,401.99	45350	\$213.40	7058141402	\$1,615.39	253	N/A
14"x18'	\$1,674.99	45370	\$213.40	7058141402	\$1,888.39	285	N/A
16"x8'	\$912.30	45408	\$271.00	7058161602	\$1,183.30	128	N/A
16"x10'	\$1,133.20	45410	\$271.00	7058161602	\$1,404.20	190	N/A
16"x12'	\$1,305.90	45430	\$271.00	7058161602	\$1,576.90	200	N/A
16"x14'	\$1,542.99	45450	\$271.00	7058161602	\$1,813.99	225	N/A
16"x16'	\$1,847.99	45470	\$271.00	7058161602	\$2,118.99	237	N/A
16"x18'	\$2,121.99	45490	\$271.00	7058161602	\$2,392.99	290	N/A
16"x20'	\$2,393.99	45510	\$271.00	7058161602	\$2,664.99	312	N/A

NOTE:

- When ordering adjustable Fluted Columns please add the product's two letter notation (AF) to the item number.
- AF = Adjustable Flute Shaft (Adjustable flute length for 6" x 8' - 30" x 30').
- Flutes can be adjusted to stop any distance from the top of the base.
- Add 60% List to alter Flutes on all Round DuraCast™ Shafts.



DuraCast™ Plain Round Tapered Columns

Bottom Diameter X Height	Plain Shaft		Cap & Base		Complete Column	Wt (lbs)	Per Pallet
	Price	Stock #	Price	Stock #	Shaft & C/B Plain		
18"x8'	\$1,702.99	45690	Call	Call	Call	172	N/A
18"x10'	\$1,817.99	45700	\$496.20	7058181802	\$2,314.19	204	N/A
18"x12'	\$1,939.99	45710	\$496.20	7058181802	\$2,436.19	245	N/A
18"x14'	\$2,019.99	45720	\$496.20	7058181802	\$2,516.19	286	N/A
18"x16'	\$2,126.99	45530	\$496.20	7058181802	\$2,623.19	335	N/A
18"x18'	\$2,343.99	45540	\$496.20	7058181802	\$2,840.19	370	N/A
18"x20'	\$2,733.99	45550	\$496.20	7058181802	\$3,230.19	418	N/A
18"x22'	\$2,962.99	45560	\$496.20	7058181802	\$3,459.19	435	N/A
18"x24'	\$3,203.99	45570	\$496.20	7058181802	\$3,700.19	467	N/A
18"x26'	\$3,556.99	45580	\$496.20	7058181802	\$4,053.19	484	N/A
20"x10'	\$2,349.99	45719	Call	Call	Call	309	N/A
20"x12'	\$2,468.99	45721	Call	Call	Call	359	N/A
20"x14'	\$2,603.99	45727	Call	Call	Call	409	N/A
20"x16'	\$2,695.99	45722	\$550.90	7058202002	\$3,246.89	434	N/A
20"x18'	\$2,769.99	45723	\$550.90	7058202002	\$3,320.89	459	N/A
20"x20'	\$2,902.99	45724	\$550.90	7058202002	\$3,453.89	509	N/A
20"x22'	\$3,035.99	45725	\$550.90	7058202002	\$3,586.89	559	N/A
20"x24'	\$3,259.99	45726	\$550.90	7058202002	\$3,810.89	609	N/A
22"x16'	\$2,859.99	45730	\$920.30	7058222202	\$3,780.29	475	N/A
22"x18'	\$3,185.99	45740	\$920.30	7058222202	\$4,106.29	535	N/A
22"x20'	\$3,439.99	45750	\$920.30	7058222202	\$4,360.29	594	N/A
22"x22'	\$3,695.99	45760	\$920.30	7058222202	\$4,616.29	685	N/A
22"x24'	\$4,036.99	45770	\$920.30	7058222202	\$4,957.29	747	N/A
22"x26'	\$4,398.99	45780	\$920.30	7058222202	\$5,319.29	809	N/A
24"x12'	\$2,522.99	45800	\$1,294.80	7058242402	\$3,817.79	508	N/A
24"x14'	\$2,600.99	45810	\$1,294.80	7058242402	\$3,895.79	588	N/A
24"x16'	\$3,119.99	45820	\$1,294.80	7058242402	\$4,414.79	671	N/A
24"x18'	\$3,615.99	45830	\$1,294.80	7058242402	\$4,910.79	755	N/A
24"x20'	\$4,250.99	45840	\$1,294.80	7058242402	\$5,545.79	839	N/A
24"x22'	\$4,756.99	45850	\$1,294.80	7058242402	\$6,051.79	922	N/A
24"x24'	\$5,264.99	45860	\$1,294.80	7058242402	\$6,559.79	1007	N/A
24"x26'	\$5,898.99	45870	\$1,294.80	7058242402	\$7,193.79	1140	N/A
24"x28'	\$6,406.99	45880	\$1,294.80	7058242402	\$7,701.79	1228	N/A
24"x30'	\$6,912.99	45890	\$1,294.80	7058242402	\$8,207.79	1316	N/A
28"x20'	\$5,989.99	45932	\$1,537.70	45908	\$7,527.69	1450	N/A
28"x22'	\$6,295.99	45933	\$1,537.70	45908	\$7,833.69	1600	N/A
28"x24'	\$6,565.99	45934	\$1,537.70	45908	\$8,103.69	1750	N/A
28"x26'	\$7,024.99	45935	\$1,537.70	45908	\$8,562.69	1950	N/A
28"x28'	\$7,601.99	45936	\$1,537.70	45908	\$9,139.69	2100	N/A
30"x20'	\$6,152.99	45956	\$2,244.20	45970	\$8,397.19	1700	N/A
30"x22'	\$6,974.99	45958	\$2,244.20	45970	\$9,219.19	1900	N/A
30"x24'	\$7,795.99	45960	\$2,244.20	45970	\$10,040.19	2100	N/A
30"x26'	\$8,616.99	45962	\$2,244.20	45970	\$10,861.19	2300	N/A
30"x28'	\$9,436.99	45964	\$2,244.20	45970	\$11,681.19	2500	N/A
30"x30'	\$10,257.99	45966	\$2,244.20	45970	\$12,502.19	2700	N/A

• Add 60% List to alter Flutes on all Round DuraCast™ Shafts.

DuraCast™ Fiberglass Columns

DuraCast™ Round Tapered Fluted Columns							
Bottom Diameter X Height	Fluted Shaft		Cap & Base*		Complete Column	Wt (lbs)	Per Pallet
	Price	Stock #	Price	Stock #	Shaft & C/B Plain		
8"x8'	\$255.30	45060	\$40.80	40051	\$296.10	65	25
8"x9'	\$276.10	45065	\$40.80	40051	\$316.90	66	25
8"x10'	\$298.00	45080	\$40.80	40051	\$338.80	73	25
10"x8'	\$307.20	45100	\$58.40	40052	\$365.60	80	16
10"x9'	\$343.10	45105	\$58.40	40052	\$401.50	88	16
10"x10'	\$380.10	45120	\$58.40	40052	\$438.50	99	16
10"x12'	\$480.50	45140	\$58.40	40052	\$538.90	122	12
12"x8'	\$378.80	45160	\$78.30	40053	\$457.10	114	9
12"x9'	\$413.50	45165	\$78.30	40053	\$491.80	120	9
12"x10'	\$450.50	45180	\$78.30	40053	\$528.80	134	9
12"x12'	\$596.00	45200	\$78.30	40053	\$674.30	162	6
12"x14'	\$1,247.00	45220	\$78.30	40053	\$1,325.30	185	N/A
12"x16'	\$1,535.00	45240	\$78.30	40053	\$1,613.30	201	N/A
12"x18'	\$2,042.10	45260	\$78.30	40053	\$2,120.40	235	N/A
14"x8'	\$942.10	45280	\$213.40	7058141402	\$1,155.50	119	6
14"x10'	\$986.99	45300	\$213.40	7058141402	\$1,200.39	149	6
14"x12'	\$1,180.99	45320	\$213.40	7058141402	\$1,394.39	185	6
14"x14'	\$1,681.99	45340	\$213.40	7058141402	\$1,895.39	222	6
16"x8'	\$1,066.99	45409	\$271.00	7058161602	\$1,337.99	128	N/A
16"x10'	\$1,403.99	45420	\$271.00	7058161602	\$1,674.99	190	N/A
16"x12'	\$1,621.99	45440	\$271.00	7058161602	\$1,892.99	200	N/A

DuraCast™ Round Tapered Split Columns

Bottom Diameter X Height	Split Shaft Plain (Does not include split kit)		Optional Adhesive Split Kit		Optional Flange Split Kit		Plain Split Column with Factory Installed Split Kit with Flange		Split Cap & Base set	
	Price	Stock #	Price	Stock #	Price	Stock #	Price	Stock #	Price	Stock #
6"x8'	\$224.30	70010608PLS	\$59.00	17102	N/A	N/A	N/A	N/A	\$48.99	7058060602S
8"x5'6"	\$207.10	70010856PLS	\$59.00	17102	\$77.60	17130	\$368.70	70010856PLKS	\$48.99	7058080802S
8"x6'	\$225.15	70010856PLS	\$59.00	17102	\$77.60	17130	\$404.95	70010856PLKS	\$48.99	7058080802S
8"x8'	\$243.20	70010808PLS	\$59.00	17102	\$77.60	17130	\$441.20	70010808PLKS	\$48.99	7058080802S
8"x9'	\$273.50	70010809PLS	\$59.00	17102	\$77.60	17130	\$486.20	70010809PLKS	\$48.99	7058080802S
8"x10'	\$325.80	70010810PLS	\$59.00	17102	\$77.60	17130	\$553.00	70010810PLKS	\$48.99	7058080802S
10"x5'6"	\$250.40	70011056PLS	\$59.00	17102	\$84.40	17132	\$419.40	70011056PLKS	\$70.99	7058101002S
10"x6'	\$275.75	70011066PLS	\$59.00	17102	\$84.40	17132	\$462.95	70011056PLKS	\$70.99	7058101002S
10"x8'	\$301.10	70011008PLS	\$59.00	17102	\$84.40	17132	\$506.50	70011008PLKS	\$70.99	7058101002S
10"x9'	\$339.70	70011009PLS	\$59.00	17102	\$84.40	17132	\$559.70	70011009PLKS	\$70.99	7058101002S
10"x10'	\$378.20	70011010PLS	\$59.00	17102	\$84.40	17132	\$612.80	70011010PLKS	\$70.99	7058101002S
10"x12'	\$525.70	70011012PLS	\$59.00	17102	\$84.40	17132	\$789.50	70011012PLKS	\$70.99	7058101002S
12"x6'	\$355.90	70011208PLS	\$59.00	17102	\$84.40	17132	\$554.00	70011208PLKS	\$93.99	7058121202S
12"x8'	\$382.00	70011208PLS	\$59.00	17102	\$84.40	17132	\$587.40	70011208PLKS	\$93.99	7058121202S
12"x9'	\$434.20	70011209PLS	\$59.00	17102	\$84.40	17132	\$654.20	70011209PLKS	\$93.99	7058121202S
12"x10'	\$485.30	70011210PLS	\$59.00	17102	\$84.40	17132	\$719.90	70011210PLKS	\$93.99	7058121202S
12"x12'	\$667.80	70011212PLS	\$59.00	17102	\$84.40	17132	\$931.60	70011212PLKS	\$93.99	7058121202S
12"x14'	\$1,067.40	45210S	\$59.00	17102	N/A	N/A	N/A	N/A	\$93.99	40053S
12"x16'	\$1,440.50	45230S	\$59.00	17102	N/A	N/A	N/A	N/A	\$93.99	40053S
12"x18'	\$2,017.40	45250S	\$59.00	17102	N/A	N/A	N/A	N/A	\$93.99	40053S
14"x8'	\$804.40	45270S	\$117.00	17107	\$84.40	17132	\$908.99	45270KS	\$256.99	7058141402S
14"x9'	\$851.40	45274S	\$117.00	17107	\$84.40	17132	\$1,017.99	45274KS	\$256.99	7058141402S
14"x10'	\$905.70	45290S	\$117.00	17107	\$84.40	17132	\$1,083.99	45290KS	\$256.99	7058141402S
14"x12'	\$1,081.90	45310S	\$117.00	17107	\$84.40	17132	\$1,278.99	45310KS	\$256.99	7058141402S
14"x14'	\$1,275.99	45330S	\$117.00	17107	N/A	N/A	N/A	N/A	\$256.99	7058141402S
14"x16'	\$1,579.99	45350S	\$117.00	17107	N/A	N/A	N/A	N/A	\$256.99	7058141402S
14"x18'	\$1,970.99	45370S	\$117.00	17107	N/A	N/A	N/A	N/A	\$256.99	7058141402S
16"x8'	\$993.10	45408S	\$117.00	17107	\$84.40	17132	\$1,078.99	45408KS	\$325.99	7058161602S
16"x10'	\$1,242.50	45410S	\$117.00	17107	\$84.40	17132	\$1,329.99	45410KS	\$325.99	7058161602S
16"x12'	\$1,437.10	45430S	\$117.00	17107	N/A	N/A	N/A	N/A	\$325.99	7058161602S
16"x14'	\$1,698.99	45450S	\$117.00	17107	N/A	N/A	N/A	N/A	\$325.99	7058161602S
16"x16'	\$2,057.99	45470S	\$117.00	17107	N/A	N/A	N/A	N/A	\$325.99	7058161602S
16"x18'	\$2,416.99	45490S	\$117.00	17107	N/A	N/A	N/A	N/A	\$325.99	7058161602S
16"x20'	\$2,734.99	45510S	\$117.00	17107	N/A	N/A	N/A	N/A	\$325.99	7058161602S
18"x8'	\$1,770.99	49227S	\$117.00	17107	N/A	N/A	N/A	N/A	\$595.99	7058181802S
18"x10'	\$1,909.99	45700S	\$117.00	17107	N/A	N/A	N/A	N/A	\$595.99	7058181802S
18"x12'	\$2,051.99	45710S	\$117.00	17107	N/A	N/A	N/A	N/A	\$595.99	7058181802S
18"x14'	\$2,166.99	45720S	\$117.00	17107	N/A	N/A	N/A	N/A	\$595.99	7058181802S
18"x16'	\$2,334.99	45530S	\$117.00	17107	N/A	N/A	N/A	N/A	\$595.99	7058181802S
18"x18'	\$2,622.99	45540S	\$117.00	17107	N/A	N/A	N/A	N/A	\$595.99	7058181802S
18"x20'	\$3,055.99	45550S	\$117.00	17107	N/A	N/A	N/A	N/A	\$595.99	7058181802S
18"x22'	\$3,357.99	45560S	\$117.00	17107	N/A	N/A	N/A	N/A	\$595.99	7058181802S
18"x24'	\$3,679.99	45570S	\$117.00	17107	N/A	N/A	N/A	N/A	\$595.99	7058181802S
18"x26'	\$4,072.99	45580S	\$117.00	17107	N/A	N/A	N/A	N/A	\$595.99	7058181802S

DuraCast™ Fiberglass Columns

DuraCast™ Round Tapered Split Columns

Bottom Diameter X Height	Split Shaft Plain (Does not include split kit)		Optional Adhesive Split Kit		Optional Flange Split Kit		Plain Split Column with Factory Installed Split Kit with Flange		Split Cap & Base set	
	Price	Stock #	Price	Stock #	Price	Stock #	Price	Stock #	Price	Stock #
20"x10'	\$2,433.99	45719S	\$117.00	17107	N/A	N/A	N/A	N/A	Call	Call
20"x12'	\$2,573.99	45721S	\$117.00	17107	N/A	N/A	N/A	N/A	Call	Call
20"x14'	\$2,742.99	45727S	\$117.00	17107	N/A	N/A	N/A	N/A	Call	Call
20"x16'	\$2,912.99	45722S	\$117.00	17107	N/A	N/A	N/A	N/A	\$661.99	7058202002S
20"x18'	\$3,032.99	45723S	\$117.00	17107	N/A	N/A	N/A	N/A	\$661.99	7058202002S
20"x20'	\$3,206.99	45724S	\$117.00	17107	N/A	N/A	N/A	N/A	\$661.99	7058202002S
20"x22'	\$3,407.99	45725S	\$117.00	17107	N/A	N/A	N/A	N/A	\$661.99	7058202002S
20"x24'	\$3,707.99	45726S	\$117.00	17107	N/A	N/A	N/A	N/A	\$661.99	7058202002S
22"x16'	\$3,055.99	45730S	\$117.00	17107	N/A	N/A	N/A	N/A	\$1,104.99	7058222202S
22"x18'	\$3,447.99	45740S	\$117.00	17107	N/A	N/A	N/A	N/A	\$1,104.99	7058222202S
22"x20'	\$3,743.99	45750S	\$117.00	17107	N/A	N/A	N/A	N/A	\$1,104.99	7058222202S
22"x22'	\$4,067.99	45760S	\$117.00	17107	N/A	N/A	N/A	N/A	\$1,104.99	7058222202S
22"x24'	\$4,484.99	45770S	\$117.00	17107	N/A	N/A	N/A	N/A	\$1,104.99	7058222202S
22"x26'	\$4,883.99	45780S	\$117.00	17107	N/A	N/A	N/A	N/A	\$1,104.99	7058222202S
24"x12'	\$2,627.99	45800S	\$117.00	17107	N/A	N/A	N/A	N/A	\$1,553.99	7058242402S
24"x14'	\$2,738.99	45810S	\$117.00	17107	N/A	N/A	N/A	N/A	\$1,553.99	7058242402S
24"x16'	\$3,315.99	45820S	\$117.00	17107	N/A	N/A	N/A	N/A	\$1,553.99	7058242402S
24"x18'	\$3,877.99	45830S	\$117.00	17107	N/A	N/A	N/A	N/A	\$1,553.99	7058242402S
24"x20'	\$4,553.99	45840S	\$117.00	17107	N/A	N/A	N/A	N/A	\$1,553.99	7058242402S
24"x22'	\$5,129.99	45850S	\$117.00	17107	N/A	N/A	N/A	N/A	\$1,553.99	7058242402S
24"x24'	\$5,712.99	45860S	\$117.00	17107	N/A	N/A	N/A	N/A	\$1,553.99	7058242402S
24"x26'	\$6,383.99	45870S	\$117.00	17107	N/A	N/A	N/A	N/A	\$1,553.99	7058242402S
24"x28'	\$7,059.99	45880S	\$117.00	17107	N/A	N/A	N/A	N/A	\$1,553.99	7058242402S
24"x30'	\$7,612.99	45890S	\$117.00	17107	N/A	N/A	N/A	N/A	\$1,553.99	7058242402S
28"x20'	\$6,293.99	45932S	\$117.00	17107	N/A	N/A	N/A	N/A	\$1,845.99	45908S
28"x22'	\$6,667.99	45933S	\$117.00	17107	N/A	N/A	N/A	N/A	\$1,845.99	45908S
28"x24'	\$7,012.99	45934S	\$117.00	17107	N/A	N/A	N/A	N/A	\$1,845.99	45908S
28"x26'	\$7,510.99	45935S	\$117.00	17107	N/A	N/A	N/A	N/A	\$1,845.99	45908S
28"x28'	\$8,255.99	45936S	\$117.00	17107	N/A	N/A	N/A	N/A	\$1,845.99	45908S
30"x20'	\$6,437.99	45956S	\$117.00	17107*	N/A	N/A	N/A	N/A	\$2,693.99	45970S
30"x22'	\$7,323.99	45958S	\$117.00	17107*	N/A	N/A	N/A	N/A	\$2,693.99	45970S
30"x24'	\$8,215.99	45960S	\$117.00	17107*	N/A	N/A	N/A	N/A	\$2,693.99	45970S
30"x26'	\$9,071.99	45962S	\$117.00	17107*	N/A	N/A	N/A	N/A	\$2,693.99	45970S
30"x28'	\$10,049.99	45964S	\$117.00	17107*	N/A	N/A	N/A	N/A	\$2,693.99	45970S
30"x30'	\$10,914.99	45966S	\$117.00	17107*	N/A	N/A	N/A	N/A	\$2,693.99	45970S

- Add 60% List to alter Flutes on all Round DuraCast™ Shafts.
- 30" split columns require 2 split kits.

17130 & 17132	17102 & 17107
Split Kit With Flange Includes 4 - 4 foot aluminum flange pieces Screws to install flange Adhesive Installation Instructions	Split Kit Includes 43" straps Adhesive 4 - Aluminum Plates with screws Installation instructions

DuraCast™ Round Fluted Tapered Split Columns

Bottom Diameter X Height	Fluted Shaft		Tuscan Cap & Base Set		Total Shaft Cap & Base Plain	Wt (lbs)	Per Pallet
	Price	Stock #	Price	Stock #			
8" X 8'	\$313.60	45060S	\$48.99	40051S	\$362.59	52	25
8" X 9'	\$341.70	45065S	\$48.99	40051S	\$390.69	62	20
8" X 10'	\$392.80	45080S	\$48.99	40051S	\$441.79	63	16
10" X 8'	\$388.90	45100S	\$70.99	40052S	\$459.89	63	16
10" X 9'	\$434.80	45105S	\$70.99	40052S	\$505.79	90	16
10" X 10'	\$482.10	45120S	\$70.99	40052S	\$553.09	122	12
10" X 12'	\$603.00	45140S	\$70.99	40052S	\$673.99	93	9
12" X 8'	\$460.50	45160S	\$93.99	40053S	\$554.49	93	9
12" X 9'	\$505.30	45165S	\$93.99	40053S	\$599.29	93	9
12" X 10'	\$559.80	45180S	\$93.99	40053S	\$653.79	104	9
12" X 12'	\$727.20	45200S	\$93.99	40053S	\$821.19	132	6
12" X 14'	\$1,192.30	45220S	\$93.99	40053S	\$1,286.29	102	6
12" X 16'	\$1,733.20	45240S	\$93.99	40053S	\$1,827.19	102	6
12" X 18'	\$2,370.20	45260S	\$93.99	40053S	\$2,464.19	102	6
14" X 8'	\$1,023.80	45280S	\$256.99	7058141402S	\$1,280.79	128	6
14" X 10'	\$1,090.99	45300S	\$256.99	7058141402S	\$1,347.98	190	N/A
14" X 12'	\$1,304.99	45320S	\$256.99	7058141402S	\$1,561.98	102	6
14" X 14'	\$1,836.99	45340S	\$256.99	7058141402S	\$2,093.98	102	6
14" X 16'	\$2,179.99	45360S	\$256.99	7058141402S	\$2,436.98	102	6
16" X 8'	\$1,139.99	45409S	\$325.99	7058161602S	\$1,465.98	245	N/A
16" X 10'	\$1,507.99	45420S	\$325.99	7058161602S	\$1,833.98	286	N/A
16" X 12'	\$1,745.99	45440S	\$325.99	7058161602S	\$2,071.98	335	N/A

NOTE: Split Kit sold separately.

17102 & 17107

Non-Flange Split Kit Includes
 43" straps
 Adhesive
 4 - Aluminum Plates with Screws
 Installation Instructions

DuraCast™ Fiberglass Columns

Attic Round Base for DuraCast™ Round Columns

Column Size	Torus		Plinth		Set	
	Price	Stock #	Price	Stock #	Price	Stock #
6"	\$29.99	54081	\$19.99	13093	\$48.99	53000
8"	\$46.99	54091	\$32.99	14033	\$78.99	53010
10"	\$69.99	54111	\$56.99	14073	\$126.99	53020
12"	\$84.99	54131	\$69.99	14113	\$154.99	53030
14"	\$100.99	54151	\$127.99	14143	\$228.99	53040
16"	\$143.99	54171	\$149.99	14173	\$293.99	53050
18"	\$189.99	54191	\$274.99	14203	\$463.99	53060
20"	\$306.99	54201	\$418.99	14213	\$725.99	53065
22"	\$388.99	54210	\$434.99	14243	\$822.99	53070
24"	\$639.99	54220	\$1,192.99	14263	\$1,831.99	53080
28"	Call	Call	Call	Call	Call	Call
30"	\$793.99	54250	\$1,472.99	14323	\$2,266.99	53100

Tuscan Round Caps & Bases for DuraCast™ Columns

Column Size	Cap Price	Stock #	Base Price	Stock #
6"	\$16.00	7058060622	\$23.00	7058060632
8"	\$18.00	7058080822	\$27.00	7058080832
10"	\$23.50	7058101022	\$35.00	7058101032
12"	\$30.00	7058121222	\$46.00	7058121232
14"	\$85.90	45403	\$127.50	45402
16"	\$122.20	45523	\$149.00	45522
18"	\$160.20	45583	\$336.20	45582
20"	\$183.20	45718	\$367.70	45717
22"	\$264.10	45733	\$656.20	45732
24"	\$346.20	45903	\$948.60	45902
28"	\$574.99	45909	\$962.71	45710
30"	\$784.10	45973	\$1,460.10	45972

Colony (Poly) Caps & Bases for DuraCast™

Column Size	Cap Price	Stock #	Base Price	Stock #	Set Price	Stock #
6"	\$9.00	7061060622	\$13.00	44095	\$22.00	7061060602
8"	\$11.00	7061080822	\$16.00	45087	\$27.00	7061080802
10"	\$16.00	7061101022	\$23.00	45147	\$39.00	7061101002
12"	\$22.00	7061121222	\$32.00	45267	\$54.00	7061121202

Tuscan (Poly) Caps and Bases for DuraCast™

Column Size	Set Price	Stock #
6"	\$39.00	7058060602
8"	\$45.00	7058080802
10"	\$58.00	7058101002
12"	\$76.00	7058121202
12"***	\$76.00	40053

SIM Colony Cap & Base Sets

Column Size	Set Price	Stock #
8"	\$21.00	6061080802
10"	\$28.00	6061101002

SIM Tuscan Round Cap and Base Set

Column Size	Set Price	Stock #
8"	\$38.00	6058080802
10"	\$51.00	6058101002
12"	\$65.00	6058121202

Tuscan Fiberglass Base

Column Size	Set Price	Stock #
8"	\$93.80	48112
10"	\$119.00	48114
12"	\$154.20	48116
14"	\$236.99	48118



Tuscan Cap



Colony Cap



Roman Doric Cap



Tuscan Base/Plinth



Colony Base/Plinth



Roman Doric Base/
Plinth



Attic Base/Plinth

*Manufactured from fiberglass.

Doric Round Caps & Bases for DuraCast™						
Column Size	Cap Price	Stock #	Base Price	Stock #	Set Price	Stock #
6"	\$24.00	7053060622	\$36.00	7053060632	\$60.00	7053060602
8"	\$25.00	7053080822	\$42.10	54436	\$62.00	7053080802
10"	\$36.00	7053101022	\$61.40	54439	\$89.00	7053101002
12"	\$49.00	7053121222	\$84.00	54442	\$122.00	7053121202
14"	\$106.70	54444	\$161.50	54445	\$268.20	54446
16"	\$198.20	54447	\$304.80	54448	\$503.00	54449
18"	\$297.30	54450	\$698.00	54451	\$995.30	54452

20" - 36" Call for Quote

- Split Charge for individual cap or base: 20% to list price
- Split Charge for special cuts: 20% to list price











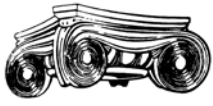

NOTE:

- Tuscan Cap and Base/Plinth are standard components for DuraCast™ Columns.
- All Caps and Base/Plinths are non-vented.
- All Caps and Base/Plinths are sold separately from the column.
- It is not recommended to split Synthetic Injection Molded (SIM) Cap & Base/Plinth sets for reassembly.



Add 20% List to Split Caps and Bases

Decorative Capitals Available for DuraCast™ Round Tapered Columns*

					
Angular Greek Ionic	Angular Greek Ionic with Necking	Decorative Roman Doric	Empire	Empire with Necking	Greek Erectheum
					
Greek Erectheum with Necking	Modern Composite	Roman Corinthian	Roman Ionic	Scamozzi	Temple of Winds

Decorative Capitals

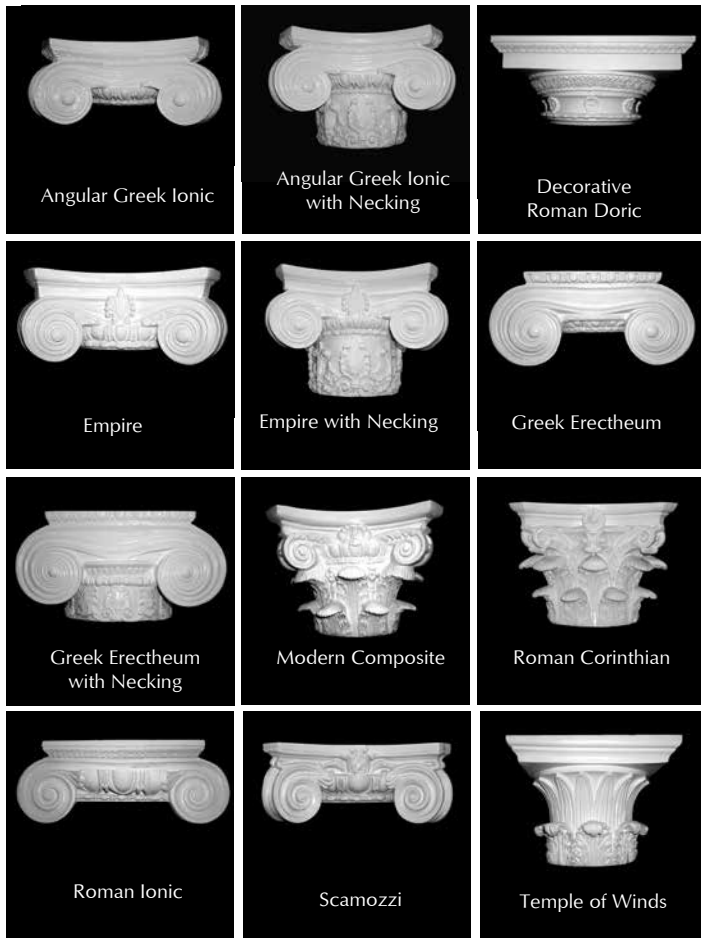

Plan Types:

Decorative Capitals can be split. Please specify shape and size of structural support if capitals are split for reassembly. The inside diameter of the Decorative Capital is significantly smaller than the inside top diameter of the column shaft.

Cut At Bead Loss for DuraCast™ Round Tapered Fiberglass Columns <i>Measurement in inches unless otherwise noted.</i>	
Column Size	Cut at Bead Loss
6"	3 ¹ / ₂
8"	4
10"	5
12"	5 ³ / ₄
14"	7
16"	8
18"	8 ⁷ / ₈
20"	9
22"	10 ¹ / ₄
24"	11 ⁵ / ₁₆
26"	11 ⁷ / ₈
28"	11 ³ / ₄
30"	14 ⁷ / ₈
36"	13 ⁵ / ₈

Plan Types for Split Decorative Columns



Decorative Capitals Quick Facts

Key Features:

- 12 Styles and Numerous Sizes Available
- Decay Resistant
- Hand Crafted with Precise Detail
- Manufactured from Lightweight Polyurethane
 - 6" - 12" are Load-Bearing
 - 14" - 30" Require Load-Bearing Plug
- Limited Lifetime Warranty

About Decorative Capitals:

- All Decorative Capitals are manufactured from lightweight polyurethane.
- Available for the following Columns: DuraCast™
- 6" - 12" are load-bearing, 14" - 30" are non-load bearing and require plug.
- All DuraCast™ Round Tapered Fiberglass Columns and Columns used with Decorative Capitals must be "cut at bead" in order for the Decorative Capital to fit properly.

Options and Ordering Tips:

- There are several considerations to be made when ordering round columns used with Decorative Capitals. The "cut at bead" loss and the Decorative Capital height must always be taken into consideration (See "Cut at Bead" Loss Chart). Additionally, a column used with a short Decorative Capital may require that a longer shaft be ordered.
- Decorative Capitals can be split in half for reassembly, pilaster application or a variety of other plan types. Capitals can be split in the field or ordered split from the factory. Please note: due to the height of some of the Decorative Capitals, it is not recommended to split the Capital in the field.

Cutting Columns at Bead/Astragal

A All DuraCast™ Round Columns should be cut flush above the bead.

B The Decorative Capital should rest on the top of the bead to allow for the proper fit on the column.

The "cut at bead" loss and the Decorative Capital height must be taken into consideration when ordering columns. A column used with a short Decorative Capital may require a longer shaft.

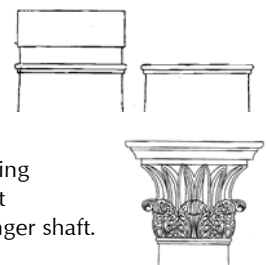

ORNAMENTAL CAPITALS FOR ROUND DuraCast™ COLUMNS LIST PRICING

Capital	6" Round		8"* Round		10"* Round		12"* Round	
	Price	Stock #	Price	Stock #	Price	Stock #	Price	Stock #
Roman Ionic	\$162.00	20RI00F06IH	\$172.00	20RI000F08IH	\$219.00	20RI00010IH	\$307.00	20RI00012IH
Temple of the Winds	\$225.00	20TW00F06IH	\$243.00	20TW00008IH	\$322.00	20TW00F10IH	\$472.00	20TW00012IH
Roman Corinthian	\$305.00	20RC00006IH	\$315.00	20RC00008IH	\$456.00	20RC00010IH	\$607.00	20RC00F12IH
Scamozzi	\$199.00	20SC00006IH	\$205.00	20SC00F08IH	\$307.00	20SC00010IH	\$432.00	20SC00012IH
Angular Greek ionic	N/A	N/A	N/A	N/A	\$591.00	20GA00010IH	\$737.00	20GA00012IH
Angular Greek Ionic with Necking	N/A	N/A	N/A	N/A	N/A	N/A	\$1,277.00	20GAN0012IH
Empire	\$412.00	20EM00006IH	N/A	N/A	\$497.00	20EM00F10IH	\$591.00	20EM00F12IH
Empire With Necking	N/A	N/A	\$617.00	20EMN0008IH	\$705.00	20EMN0010IH	\$853.00	20EMN0012IH
Modern Composite	\$387.00	20MC00F06IH	N/A	N/A	\$531.00	20MC00010IH	N/A	N/A
Greek Erectheum	N/A	N/A	\$285.00	20GE00008IH	\$346.00	20GE00010IH	\$473.00	20GE00012IH
Greek Erectheum with Necking	N/A	N/A	\$557.00	20GEN0008IH	\$617.00	20GEN0F10IH	\$737.00	20GEN0012IH
Decorative Roman Doric	N/A	N/A	\$417.00	20DD00008IH	\$507.00	20DD00010IH	\$637.00	20DD00012IH

Capital	14" Round		16" Round		18" Round		20" Round	
	Price	Stock #	Price	Stock #	Price	Stock #	Price	Stock #
Roman Ionic	\$493.50	77347	\$792.99	77261	\$1,007.99	77271	\$1,149.99	77265
Greek Ionic	\$444.99	77349	\$891.99	77161	\$1,132.99	77171	\$1,293.99	77173
Temple of the Winds	\$638.99	77541	\$988.99	77561	\$1,299.99	77571	\$1,457.99	77573
Roman Corinthian	\$1,188.20	77343	\$1,529.20	77361	\$1,976.50	77363	\$2,338.10	77365
Scamozzi	\$675.60	77345	\$935.99	77461	\$1,149.99	77471	\$1,298.99	77473

* Load Bearing

Capital	22" Round		24" Round		30" Round		
	Price	Stock #	Price	Stock #	Price	Stock #	
Roman Ionic		\$1,295.99	77267	\$1,726.99	77269	N/A	N/A
Greek Ionic		\$1,457.99	77175	\$2,331.99	77177	\$3,558.99	77183
Temple of the Winds		\$1,618.99	77575	\$2,104.99	77577	N/A	N/A
Roman Corinthian		\$2,698.30	77367	\$3,774.90	77369	N/A	N/A
Scamozzi		\$1,438.99	77475	\$1,870.99	77477	\$3,715.99	77483

Split charge for ornamental capitals: add 20% to list price

*Necking detail may vary.

NOTE:

- 6" - 12" Decorative Capitals are load bearing (unless split) and manufactured from lightweight polyurethane.
- 14" - 30" Decorative Capitals are non-load bearing (requires plug) and manufactured from lightweight polyurethane.
- Specify size and shape of structural support if Decorative Capitals are split for reassembly. The inside diameter of the Decorative Capital is significantly smaller than the inside top diameter of the column shaft.
- All Decorative Capitals are sold separately from the column.

DuraCast™ Fiberglass Columns



Bead is adjustable and is applied in the field. Bead sold separately

NOTE:

- When ordering adjustable Fluted Columns please add the two letter notation (AF) to the item number.
- AF = Adjustable Flute Shaft (Adjustable flute length for 8" x 6' - 24" x 30'). Flutes can be adjusted to stop any distance from the top of the base.

NOTE: Beads are sold separately. See page 15 for pricing.

*Add 60% List to alter flutes on all Round DuraCast™ shafts.

DuraCast™ Plain Round Non-Tapered Columns

Bottom Diameter X Height	Price	Shaft Stock #	Tuscan Cap & Base Price	Tuscan Cap & Base Stock #	Total Shaft Cap & Base Plain	Wt (lbs)	Per Pallet
8"x6'	\$188.30	49024	\$73.50	52013	\$261.80	52	25
8"x8'	\$206.80	49025	\$73.50	52013	\$280.30	52	25
8"x9'	\$254.10	49029	\$73.50	52013	\$327.60	52	25
8"x10'	\$256.40	49090	\$73.50	52013	\$329.90	62	20
10"x6'	\$217.80	49044	\$107.90	52016	\$325.70	63	16
10"x8'	\$262.60	49045	\$107.90	52016	\$370.50	63	16
10"x9'	\$290.00	49049	\$107.90	52016	\$397.90	63	16
10"x10'	\$345.40	49100	\$107.90	52016	\$453.30	90	16
10"x12'	\$451.70	49125	\$107.90	52016	\$559.60	122	12
12"x6'	\$274.90	49064	\$138.10	52019	\$413.00	93	9
12"x8'	\$323.99	49065	\$138.10	52019	\$462.09	93	9
12"x9'	\$364.99	49069	\$138.10	52019	\$503.09	93	9
12"x10'	\$413.99	49110	\$138.10	52019	\$552.09	104	9
12"x12'	\$516.99	49135	\$138.10	52019	\$655.09	132	6
14"x6'	\$524.99	49079	\$286.40	52023	\$811.39	102	6
14"x8'	\$740.99	49080	\$286.40	52023	\$1,027.39	102	6
14"x9'	\$778.99	49081	\$286.40	52023	\$1,065.39	102	6
14"x10'	\$823.99	49120	\$286.40	52023	\$1,110.39	128	6
14"x12'	\$989.99	49145	\$286.40	52023	\$1,276.39	152	5
14"x14'	\$1,140.99	49180	\$286.40	52023	\$1,427.39	190	N/A
16"x6'	\$679.99	49194	\$379.50	52026	\$1,059.49	102	6
16"x8'	\$914.99	49195	\$379.50	52026	\$1,294.49	102	6
16"x9'	\$954.99	49199	\$379.50	52026	\$1,334.49	102	6
16"x10'	\$1,185.99	49200	\$379.50	52026	\$1,565.49	204	N/A
16"x12'	\$1,373.99	49205	\$379.50	52026	\$1,753.49	245	N/A
16"x14'	\$1,790.99	49210	\$379.50	52026	\$2,170.49	286	N/A
16"x16'	\$1,964.99	49215	\$379.50	52026	\$2,344.49	335	N/A
16"x18'	\$2,191.99	49220	\$379.50	52026	\$2,571.49	370	N/A
16"x20'	\$2,471.99	49225	\$379.50	52026	\$2,851.49	418	N/A
18"x6'	\$1,564.99	49226	\$540.20	52029	\$2,105.19	204	N/A
18"x8'	\$1,704.99	49227	\$540.20	52029	\$2,245.19	204	N/A
18"x9'	\$1,763.99	49234	\$540.20	52029	\$2,304.19	204	N/A
18"x10'	\$1,957.99	49228	\$540.20	52029	\$2,498.19	204	N/A
18"x12'	\$2,122.99	49229	\$540.20	52029	\$2,663.19	245	N/A
18"x14'	\$2,157.99	49230	\$540.20	52029	\$2,698.19	286	N/A
18"x16'	\$2,301.99	49231	\$540.20	52029	\$2,842.19	335	N/A
18"x18'	\$2,536.99	49232	\$540.20	52029	\$3,077.19	370	N/A
18"x20'	\$2,902.99	49233	\$540.20	52029	\$3,443.19	418	N/A
24"x8'	\$1,964.99	49236	\$1,050.99	52038	\$3,015.98	420	N/A
24"x9'	\$2,186.99	49238	\$1,050.99	52038	\$3,237.98	430	N/A
24"x10'	\$2,457.99	49237	\$1,050.99	52038	\$3,508.98	450	N/A
24"x12'	\$2,734.99	49242	\$1,050.99	52038	\$3,785.98	493	N/A
24"x14'	\$3,189.99	49244	\$1,050.99	52038	\$4,240.98	549	N/A
24"x16'	\$3,645.99	49246	\$1,050.99	52038	\$4,696.98	567	N/A
24"x18'	\$4,087.99	49240	\$1,050.99	52038	\$5,138.98	739	N/A
24"x20'	\$4,529.99	49250	\$1,050.99	52038	\$5,580.98	821	N/A
24"x22'	\$4,982.99	49255	\$1,050.99	52038	\$6,033.98	NA	N/A
24"x24'	\$5,481.99	49260	\$1,050.99	52038	\$6,532.98	NA	N/A
24"x26'	\$6,030.99	49265	\$1,050.99	52038	\$7,081.98	NA	N/A
24"x28'	\$6,634.99	49270	\$1,050.99	52038	\$7,685.98	NA	N/A
24"x30'	\$7,298.99	45272	\$1,050.99	52038	\$8,349.98	NA	N/A

DuraCast™ Round Split Non-Taper Columns

Bottom Diameter X Height	Split Shaft Plain (Does not include split kit)		Optional Adhesive Split Kit		Optional Flange Split Kit		Plain Split Column with Factory Installed Split Kit with Flange		Split Cap & Base set	
	Price	Stock #	Price	Stock #	Price	Stock #	Price	Stock #	Price	Stock #
8"x6'	\$232.00	49024S	\$59.00	17102	\$77.60	17130	\$401.00	49024KS	\$88.99	52013S
8"x8'	\$265.10	49025S	\$59.00	17102	\$77.60	17130	\$463.20	49025KS	\$88.99	52013S
8"x9'	\$326.30	49029S	\$59.00	17102	\$77.60	17130	\$509.30	49029KS	\$88.99	52013S
8"x10'	\$351.20	49090S	\$59.00	17102	\$77.60	17130	\$578.50	49090KS	\$88.99	52013S
10"x6'	\$289.20	49044S	\$59.00	17102	\$84.40	17132	\$426.90	49044KS	\$129.99	52016S
10"x8'	\$328.80	49045S	\$59.00	17102	\$84.40	17132	\$534.20	49045KS	\$129.99	52016S
10"x9'	\$384.50	49049S	\$59.00	17102	\$84.40	17132	\$593.70	49049KS	\$129.99	52016S
10"x10'	\$447.50	49100S	\$59.00	17102	\$84.40	17132	\$682.00	49100KS	\$129.99	52016S
10"x12'	\$574.10	49125S	\$59.00	17102	\$84.40	17132	\$837.80	49125KS	\$129.99	52016S
12"x6'	\$336.20	49064S	\$59.00	17102	\$84.40	17132	\$512.40	49064KS	\$165.99	52019S
12"x8'	\$396.99	49065S	\$59.00	17102	\$84.40	17132	\$646.30	49065KS	\$165.99	52019S
12"x9'	\$447.99	49069S	\$59.00	17102	\$84.40	17132	\$717.20	49069KS	\$165.99	52019S
12"x10'	\$512.99	49110S	\$59.00	17102	\$84.40	17132	\$803.60	49110KS	\$165.99	52019S
12"x12'	\$659.99	49135S	\$59.00	17102	\$84.40	17132	\$969.00	49135KS	\$165.99	52019S
14"x6'	\$629.99	49079S	\$117.00	17107	N/A	N/A	N/A	N/A	\$343.99	52023S
14"x8'	\$814.99	49080S	\$117.00	17107	N/A	N/A	N/A	N/A	\$343.99	52023S
14"x9'	\$861.99	49081S	\$117.00	17107	N/A	N/A	N/A	N/A	\$343.99	52023S
14"x10'	\$922.99	49120S	\$117.00	17107	N/A	N/A	N/A	N/A	\$343.99	52023S
14"x12'	\$1,107.99	49145S	\$117.00	17107	N/A	N/A	N/A	N/A	\$343.99	52023S
14"x14'	\$1,430.99	49180S	\$117.00	17107	N/A	N/A	N/A	N/A	\$343.99	52023S
16"x6'	\$734.99	49194S	\$117.00	17107	N/A	N/A	N/A	N/A	\$455.99	52026S
16"x8'	\$999.99	49195S	\$117.00	17107	N/A	N/A	N/A	N/A	\$455.99	52026S
16"x9'	\$1,099.99	49199S	\$117.00	17107	N/A	N/A	N/A	N/A	\$455.99	52026S
16"x10'	\$1,280.99	49200S	\$117.00	17107	N/A	N/A	N/A	N/A	\$455.99	52026S
16"x12'	\$1,491.99	49205S	\$117.00	17107	N/A	N/A	N/A	N/A	\$455.99	52026S
16"x14'	\$1,946.99	49210S	\$117.00	17107	N/A	N/A	N/A	N/A	\$455.99	52026S
16"x16'	\$2,136.99	49215S	\$117.00	17107	N/A	N/A	N/A	N/A	\$455.99	52026S
16"x18'	\$2,553.99	49220S	\$117.00	17107	N/A	N/A	N/A	N/A	\$455.99	52026S
16"x20'	\$2,874.99	49225S	\$117.00	17107	N/A	N/A	N/A	N/A	\$455.99	52026S

• Add 60% List to alter Flutes on all Round DuraCast™ Shafts.

DuraCast™ Round Non-Tapered Beads



Column Size	Bead Item #	Price
8"	F50108PGN	\$73.99
10"	F50110PGN	\$89.99
12"	F50112PGN	\$104.99
14"	F50114PGN	\$118.99
16"	F50116PGN	\$156.99
18"	F50118PGN	\$193.99
24"	F50120PGN	\$216.99

NOTE: Beads are sold separately from all DuraCast™ round non-tapered shafts.

DuraCast™ Fiberglass Columns

DuraCast™ Round Split Non-Taper Columns

Bottom Diameter X Height	Split Shaft Plain (Does not include split kit)		Optional Adhesive Split Kit		Optional Flange Split Kit		Plain Split Column with Factory Installed Split Kit with Flange		Split Cap & Base set	
	Price	Stock #	Price	Stock #	Price	Stock #	Price	Stock #	Price	Stock #
18"x6'	\$1,613.99	49226S	\$117.00	17107	N/A	N/A	N/A	N/A	\$648.99	52029S
18"x8'	\$1,774.99	49227S	\$117.00	17107	N/A	N/A	N/A	N/A	\$648.99	52029S
18"x9'	\$1,842.99	49234S	\$117.00	17107	N/A	N/A	N/A	N/A	\$648.99	52029S
18"x10'	\$2,050.99	49228S	\$117.00	17107	N/A	N/A	N/A	N/A	\$648.99	52029S
18"x12'	\$2,233.99	49229S	\$117.00	17107	N/A	N/A	N/A	N/A	\$648.99	52029S
18"x14'	\$2,295.99	49230S	\$117.00	17107	N/A	N/A	N/A	N/A	\$648.99	52029S
18"x16'	\$2,569.99	49231S	\$117.00	17107	N/A	N/A	N/A	N/A	\$648.99	52029S
18"x18'	\$2,866.99	49232S	\$117.00	17107	N/A	N/A	N/A	N/A	\$648.99	52029S
18"x20'	\$3,262.99	49233S	\$117.00	17107	N/A	N/A	N/A	N/A	\$648.99	52029S
24"x8'	\$2,034.99	49236S	\$117.00	17107	N/A	N/A	N/A	N/A	\$1,261.99	52038S
24"x10'	\$2,290.20	49237S	\$117.00	17107	N/A	N/A	N/A	N/A	\$1,261.99	52038S
24"x12'	\$2,545.99	49242S	\$117.00	17107	N/A	N/A	N/A	N/A	\$1,261.99	52038S
24"x14'	\$3,552.99	49244S	\$117.00	17107	N/A	N/A	N/A	N/A	\$1,261.99	52038S
24"x16'	\$4,084.99	49246S	\$117.00	17107	N/A	N/A	N/A	N/A	\$1,261.99	52038S
24"x18'	\$4,609.99	49240S	\$117.00	17107	N/A	N/A	N/A	N/A	\$1,261.99	52038S
24"x20'	\$5,135.99	49250S	\$117.00	17107	N/A	N/A	N/A	N/A	\$1,261.99	52038S
24"x22'	\$5,979.99	49255S	\$117.00	17107	N/A	N/A	N/A	N/A	\$1,261.99	52038S
24"x24'	\$6,578.99	49260S	\$117.00	17107	N/A	N/A	N/A	N/A	\$1,261.99	52038S
24"x26'	\$7,237.99	49265S	\$117.00	17107	N/A	N/A	N/A	N/A	\$1,261.99	52038S
24"x28'	\$7,961.99	49270S	\$117.00	17107	N/A	N/A	N/A	N/A	\$1,261.99	52038S
24"x30'	\$8,758.99	49272S	\$117.00	17107	N/A	N/A	N/A	N/A	\$1,261.99	52038S

- Add 60% List to alter Flutes on all Round DuraCast™ Shafts.

17130 & 17132	17102 & 17107
Split Kit With Flange Includes 4 - 4 foot aluminum flange pieces Screws to install flange Adhesive Installation Instructions	Split Kit Includes 43" straps Adhesive 4 - Aluminum Plates with screws Installation instructions

DuraCast™ Square Non-Tapered Columns

Bottom Diameter X Height	Plain Shaft w/Neck Mould		Fluted Shaft w/Neck Mould		Cap & base Set		Complete Column Shaft & C/B Set		(lb.)	Pallet
	Price	Stock #	Price	Stock #	Price	Stock #	Plain	Fluted		
6"x6'	\$231.00	45988	N/A	N/A	\$51.99	54700	\$282.99	N/A	46	24
6"x8'	\$264.40	45990	N/A	N/A	\$51.99	54700	\$316.39	N/A	61	24
6"x9'	\$282.30	45991	N/A	N/A	\$51.99	54700	\$334.29	N/A	70	24
6"x10'	\$297.70	45992	N/A	N/A	\$51.99	54700	\$349.69	N/A	77	24
8"x6'	\$286.50	46008	N/A	N/A	\$51.99	54702	\$338.49	N/A	59	20
8"x8'	\$338.40	46010	\$453.10	46210	\$51.99	54702	\$390.39	\$505.09	78	20
8"x9'	\$367.30	46011	\$536.90	46211	\$51.99	54702	\$419.29	\$588.89	89	20
8"x10'	\$396.10	46012	\$568.60	46212	\$51.99	54702	\$448.09	\$620.59	98	20
8"x12'	\$482.80	46014	N/A	N/A	\$51.99	54702	\$534.79	N/A	117	15
10"x5'1"	\$295.70	46026	N/A	N/A	\$75.99	54704	\$371.69	N/A	51	16
10"x6'	\$373.00	46028	N/A	N/A	\$75.99	54704	\$448.99	N/A	75	16
10"x8'	\$426.20	46030	N/A	N/A	\$75.99	54704	\$502.19	N/A	102	16
10"x9'	\$470.10	46031	N/A	N/A	\$75.99	54704	\$546.09	N/A	114	16
10"x10'	\$512.80	46032	\$752.00	46232	\$75.99	54704	\$588.79	\$827.99	132	16
10"x12'	\$609.90	46034	N/A	N/A	\$75.99	54704	\$685.89	N/A	147	12
10"x14'	\$989.80	46036	N/A	N/A	\$75.99	54704	\$1,065.79	N/A	168	N/A
10"x16'	\$1,229.60	46038	N/A	N/A	\$75.99	54704	\$1,305.59	N/A	203	N/A
12"x8'	\$532.40	46050	N/A	N/A	\$122.99	54706	\$655.39	N/A	120	9
12"x9'	\$587.90	46051	N/A	N/A	\$122.99	54706	\$710.89	N/A	140	9
12"x10'	\$643.40	46052	N/A	N/A	\$122.99	54706	\$766.39	N/A	160	9
12"x12'	\$744.90	46054	N/A	N/A	\$122.99	54706	\$867.89	N/A	197	6
12"x14'	\$1,335.30	46056	N/A	N/A	\$122.99	54706	\$1,458.29	N/A	225	N/A
12"x16'	\$1,432.40	46058	N/A	N/A	\$122.99	54706	\$1,555.39	N/A	257	N/A
12"x18'	\$1,732.99	46060	N/A	N/A	\$122.99	54706	\$1,855.98	N/A	289	N/A
14"x8'	\$1,104.99	46070	N/A	N/A	\$199.99	54708	\$1,304.98	N/A	185	N/A
14"x10'	\$1,351.99	46072	N/A	N/A	\$199.99	54708	\$1,551.98	N/A	210	N/A
14"x12'	\$1,690.99	46074	N/A	N/A	\$199.99	54708	\$1,890.98	N/A	235	N/A
14"x14'	\$1,898.99	46076	N/A	N/A	\$199.99	54708	\$2,098.98	N/A	250	N/A
16"x8'	\$1,406.99	46090	N/A	N/A	\$283.99	54710	\$1,690.98	N/A	242	N/A
16"x10'	\$1,556.99	46092	N/A	N/A	\$283.99	54710	\$1,840.98	N/A	301	N/A
16"x12'	\$1,754.99	46094	N/A	N/A	\$283.99	54710	\$2,038.98	N/A	362	N/A
16"x14'	\$1,898.99	46096	N/A	N/A	\$283.99	54710	\$2,182.98	N/A	422	N/A
16"x16'	\$2,099.99	46098	N/A	N/A	\$283.99	54710	\$2,383.98	N/A	482	N/A
16"x18'	\$2,305.99	46100	N/A	N/A	\$283.99	54710	\$2,589.98	N/A	542	N/A
16"x20'	\$2,507.99	46102	N/A	N/A	\$283.99	54710	\$2,791.98	N/A	602	N/A

Features

- Limited Lifetime Warranty.
- DuraCast™ columns are cast from fiber reinforced polymers
- Weatherproof
- Insect proof
- Virtually maintenance free
- Load bearing
- Will never rot like wood columns
- Has many interior uses

What You Need To Know

- A complete column consists of shaft, neck moulding, cap, and base.
- Cap and base slide over shaft. The shaft rests on floor.
- Neck moulding is included with each column and must be applied.
- DuraCast™ columns used outside should not be painted using dark colors.
- For transportation purposes, small sections of split columns are left partially intact.
- Split columns are not load bearing.
- Pre-drill column prior to installing screws.
- Automotive body filler works great for minor repairs.
- When ordering a cap and base set, the Tuscan model is shipped unless otherwise specified.

DuraCast™ Fiberglass Columns

DuraCast™ Square Split Non-Tapered Columns

Bottom Width X Height	Plain Split Shaft (Does not include Split Kit)		Fluted Split Shaft (Does not include Split Kit)		Split Kit		Split Cap & Base Set	
	Price	Stock #	Price	Stock #	Price	Stock #	Price	Stock #
6"x6'	\$274.80	45988S	N/A	N/A	\$59.00	17102	\$62.99	54700S
6"x8'	\$322.80	45990S	N/A	N/A	\$59.00	17102	\$62.99	54700S
6"x9'	\$367.60	45991S	N/A	N/A	\$59.00	17102	\$62.99	54700S
6"x10'	\$399.80	45992S	N/A	N/A	\$59.00	17102	\$62.99	54700S
8"x6'	\$325.80	46008S	N/A	N/A	\$59.00	17102	\$62.99	54702S
8"x8'	\$391.00	46010S	\$511.40	46210S	\$59.00	17102	\$62.99	54702S
8"x9'	\$426.30	46011S	\$605.90	46211S	\$59.00	17102	\$62.99	54702S
8"x10'	\$481.60	46012S	\$663.30	46212S	\$59.00	17102	\$62.99	54702S
8"x12'	\$593.10	46014S	N/A	N/A	\$59.00	17102	\$62.99	54702S
10"x5'11"	\$334.80	46026S	N/A	N/A	\$59.00	17102	\$91.99	54704S
10"x6'	\$428.10	46028S	N/A	N/A	\$59.00	17102	\$91.99	54704S
10"x8'	\$499.60	46030S	N/A	N/A	\$59.00	17102	\$91.99	54704S
10"x9'	\$552.80	46031S	N/A	N/A	\$59.00	17102	\$91.99	54704S
10"x10'	\$604.60	46032S	\$854.10	46232S	\$59.00	17102	\$91.99	54704S
10"x12'	\$720.10	46034S	N/A	N/A	\$59.00	17102	\$91.99	54704S
10"x14'	\$1,181.20	46036S	N/A	N/A	\$59.00	17102	\$91.99	54704S
10"x16'	\$1,345.10	46038S	N/A	N/A	\$59.00	17102	\$91.99	54704S
12"x8'	\$605.90	46050S	N/A	N/A	\$59.00	17102	\$147.99	54706S
12"x9'	\$670.60	46051S	N/A	N/A	\$59.00	17102	\$147.99	54706S
12"x10'	\$741.80	46052S	N/A	N/A	\$59.00	17102	\$147.99	54706S
12"x12'	\$863.10	46054S	N/A	N/A	\$59.00	17102	\$147.99	54706S
12"x14'	\$1,530.20	46056S	N/A	N/A	\$59.00	17102	\$147.99	54706S
12"x16'	\$1,640.60	46058S	N/A	N/A	\$59.00	17102	\$147.99	54706S
12"x18'	\$2,062.99	46060S	N/A	N/A	\$59.00	17102	\$147.99	54706S
14"x8'	\$1,174.99	46070S	N/A	N/A	\$117.00	17107	\$239.99	54708S
14"x10'	\$1,454.99	46072S	N/A	N/A	\$117.00	17107	\$239.99	54708S
14"x12'	\$1,826.99	46074S	N/A	N/A	\$117.00	17107	\$239.99	54708S
14"x14'	\$2,047.99	46076S	N/A	N/A	\$117.00	17107	\$239.99	54708S
16"x8'	\$1,476.99	46090S	N/A	N/A	\$117.00	17107	\$340.99	54710S
16"x10'	\$1,650.99	46092S	N/A	N/A	\$117.00	17107	\$340.99	54710S
16"x12'	\$1,869.99	46094S	N/A	N/A	\$117.00	17107	\$340.99	54710S
16"x14'	\$2,198.20	46096S	N/A	N/A	\$117.00	17107	\$340.99	54710S
16"x16'	\$2,299.99	46098S	N/A	N/A	\$117.00	17107	\$340.99	54710S
16"x18'	\$2,587.99	46100S	N/A	N/A	\$117.00	17107	\$340.99	54710S
16"x20'	\$2,832.99	46102S	N/A	N/A	\$117.00	17107	\$340.99	54710S

- Neck Mould included but not applied
- Custom Split Columns - Add 20%

17102 & 17107 Split Kit Includes 43" straps Adhesive 4 - Aluminum Plates with Screws Installation Instructions

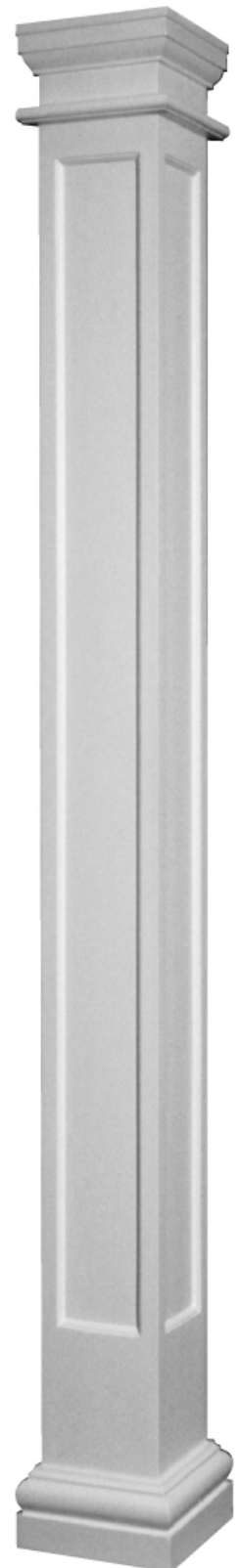

DuraCast™ Recessed Panel Non-Tapered Columns

Bottom Width X Height	Price	Shaft Stock #	Cap & Base Set		Complete Column		
			Price	Stock #	Shaft & C/B Set Price	Wt (lbs)	Per Pallet
8"X8'	\$457.99	46382	\$ 51.99	54702	\$509.98	116	20
8"X9'	\$524.99	46384	\$ 51.99	54702	\$576.98	129	20
8"X10'	\$534.99	46386	\$ 51.99	54702	\$586.98	142	20
10"X8'	\$575.99	46402	\$ 75.99	54704	\$651.98	130	16
10"X9'	\$678.99	46404	\$ 75.99	54704	\$754.98	146	16
10"X10'	\$691.99	46406	\$ 75.99	54704	\$767.98	165	16
12"X8'	\$893.99	46422	\$ 122.99	54706	\$1,016.98	180	9
12"X9'	\$987.99	46424	\$ 122.99	54706	\$1,110.98	202	9
12"X10'	\$1,078.99	46426	\$ 122.99	54706	\$1,201.98	250	9
12"X12'	\$1,254.99	46428	\$ 122.99	54706	\$1,377.98	320	9
12"X14'	\$1,764.99	46430	\$ 122.99	54706	\$1,887.98	390	N/A
14"X8'	\$1,828.99	46442	\$ 199.99	54708	\$2,028.98	240	6
14"X10'	\$1,909.99	46446	\$ 199.99	54708	\$2,109.98	308	6
14"X14'	\$2,789.99	46450	\$ 199.99	54708	\$2,989.98	445	N/A

- Recommend PVC Recessed Panel Column for split applications.

DuraCast™ Fiberglass Columns



DuraCast™ Craftsman Columns

Bottom Width X Height	Price	Shaft Stock #	Cap & Base Set* Price	Cap & Base Set* Stock #	Column Shaft & C/B Set Price	Wt. (lbs.)	Per Pallet
10"X5.5"X66"	\$350.40	46358	\$74.10	46359	\$424.50	54	8
10.25"x7.5"x7'	\$521.50	70061007PL	\$91.40	7062101002	\$612.90	70	8
12"X10"X6'	\$672.60	46336	\$133.50	46341	\$806.10	70	6
12"X10"X10'	\$809.90	46340	\$133.50	46341	\$943.40	110	6
14"X12"X9'	\$1,201.20	70061409PL	\$138.50	7062141402	\$1,339.70	212	4
16"X9"X58"	\$445.90	46350	\$160.10	46351	\$606.00	80	4
16"X9"X6'	\$683.60	46362	\$168.20	46355	\$851.80	102	4
16"X9"X8'	\$797.80	46354	\$168.20	46355	\$966.00	143	4

- 16" bases are not interchangeable.
- All dimensions are nominal.
- Neck Mould included but not applied.

DuraCast™ Craftsman Split Columns

Bottom Width X Height	Plain Split Shaft Price	Plain Split Shaft Stock #	Split Kit Price	Split Kit Stock #	Split Cap & Base Set Price	Split Cap & Base Set Stock #
10"X5.5"X66"	\$406.50	46358S	\$59.00	17102	\$88.99	46359S
10.25"x7.5"x7'	\$605.20	70061007PLS	\$59.00	17102	\$109.99	7062101002S
12"X10"X6'	\$730.90	46336S	\$59.00	17102	\$160.99	46341S
12"X10"X10'	\$924.70	46340S	\$59.00	17102	\$160.99	46341S
14"X12"X9'	\$1,393.70	70061409PLS	\$117.00	17107	\$166.99	7062141402S
16"X9"X58"	\$495.30	46350S	\$117.00	17107	\$192.99	46351S
16"X9"X6'	\$744.80	46362S	\$117.00	17107	\$201.99	46355S
16"X9"X8'	\$887.60	46354S	\$117.00	17107	\$201.99	46355S

17102 & 17107

Split Kit Includes

43" straps

Adhesive

4 - Aluminum Plates with Screws
Installation Instructions

Neck Moulding



No. 54498 - 6" & 8" - 1" x 13/16"
Square Neck Mould

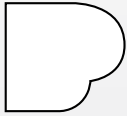

No. 54500 - 10" & 12" - 1" x 1-1/8"
Square Neck Mould

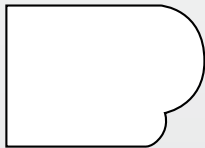

No. 54501 - 14" & 16" - 1-1/8" x 1-3/8"
Square Neck Mould

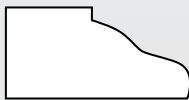

8' = No. 54502 - 1/2" x 1"
10' = No. 54512 - 1/2" x 1"

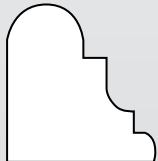

10' = No. 54503 - 1" x 11/16"



10' = No. 54504 - 3/4" x 1"



10' = No. 54505 - 3/4" x 15/16"

DuraCast™ Square Panel and Neck Moulding

Special Neck Mould Instructions for Scamozzi, Greek Ionic, and Roman Ionic Capitals for Square DuraCast™ Columns

Omitting neck mould - Because of the beaded rim at the base of these capitals, they may be installed without neck mould. The beaded edge serves the same purpose aesthetically as a neck mould. Standard installation instructions for capitals should be followed, omitting references to neck mould.

Using neck mould - If neck mould is to be used, it should be coped to fit around the scrolls of the capital. See appropriate illustration below.

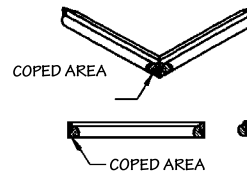

Without Neck Mould -SCAMOZZI-

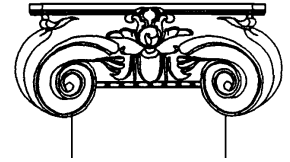

With Neck Mould -SCAMOZZI-

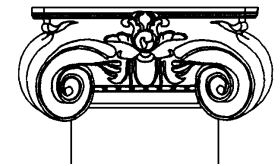

SQUARE DuraCast™ COLUMNS NECK MOULD (INCLUDED WITH EACH COLUMN)

Stock #	Description	Size	Length	List Price
54498	For use with 6" and 8" Square DuraCast™ Columns	1"	63"	\$19.90
54500	For use with 10" and 12" Square DuraCast™ Columns	1"	63"	\$24.40
54501	For use with 14" and 16" and larger Square DuraCast™ Columns	1-1/8"	63"	\$33.50

PYRAMID CAPS For DuraCast™ COLUMNS (For use when DuraCast™ column is used as a newel)

Stock #	Description	List Price
03909	Pyramid Cap for use with 6" Square DuraCast™ as Newel	\$79.30
54351	Pyramid Cap for use with 10" Square DuraCast™ as Newel	\$99.10
45981	Pyramid Cap for use with 10" Round DuraCast™ as Newel	\$80.90
45985	Pyramid Cap for use with 10" No-Taper Round DuraCast™ as Newel	\$101.20

PLAIN SQUARE DuraCast™ COLUMN PANEL MOULDING

Stock #	Length	List Price
54502	8'	\$26.00
54512	10'	\$32.10
54503	10'	\$38.10
54504	10'	\$32.10
54505	10'	\$30.50

One Piece Neck Mould for No Taper Columns

Column Size	Price	SKU
8"	\$73.99	F50008PGN
10"	\$89.99	F50010PGN
12"	\$104.99	F50012PGN
14"	\$118.99	F50014PGN
16"	\$156.99	F50016PGN
18"	\$193.99	F50018PGN
24"	\$216.99	F50024PGN

Square Splitting Options

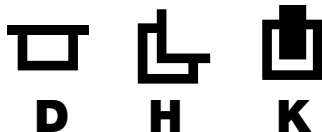



Roman Ionic



Greek Ionic



Temple of the Winds



Roman Corinthian



Scamozzi

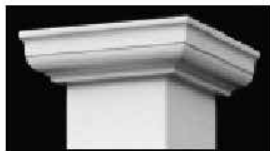

Tuscan Cap



Tuscan Base

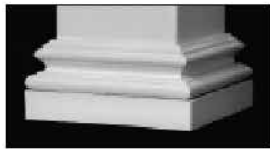

Attic Base

DuraCast™ Square Ornamental Capitals

Capital	6" Square		8" Square		10" Square		12" Square		16" Square	
	Price	Stock #	Price	Stock #	Price	Stock #	Price	Stock #	Price	Stock #
Roman Ionic	\$161.99	77592	\$176.99	77621	\$225.99	77622	\$315.99	77623	\$889.99	77625
Greek Ionic	\$161.99	77591	\$176.99	77641	\$225.99	77642	\$315.99	77643	\$889.99	77645
Temple of the Winds*	\$225.99	77595	\$278.40	77601	\$521.20	77602	\$775.99	77603	\$988.99	77605
Roman Corinthian*	\$388.99	77593	\$485.99	77631	\$775.99	77632	\$970.99	77633	\$1,527.90	77635
Scamozzi	\$194.99	77594	\$211.99	77611	\$315.99	77612	\$444.99	77613	\$1,049.99	77615

* Not recommended with fluted and recessed panel square DuraCast™ columns

• Split charge for ornamental capitals: add 20% to list price

Ornamental Capitals for SQUARE DuraCast™ Columns

Adding an ornamental capital to a square DuraCast™ column DOES NOT change the length of the column shaft. The ornamental capital simply slides over the shaft. Neck moulding can be applied or not.

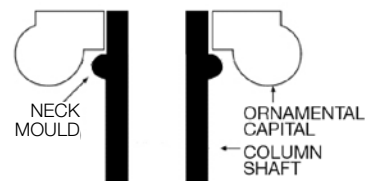

Features

- Molded from polyurethane resin
- Lightweight for easy installation
- Weather, rot, and bug-proof

What You Need To Know

- Adding an ornamental capital to a square DuraCast™ column does not change the length of the column shaft.

DuraCast™ Caps and Bases for Square Columns

Column Size	Attic Bases for Square DuraCast™ Columns					
	Torus		Plinth		Set	
	Price	Stock #	Price	Stock #	Price	Stock #
6"	\$43.99	54395	\$29.99	54397	\$72.99	54398
8"	\$46.99	54401	\$32.99	54403	\$78.99	54404
10"	\$69.99	54405	\$57.99	54407	\$126.99	54408
12"	\$84.99	54409	\$70.99	54411	\$154.99	54412
16"	\$143.99	54417	\$150.99	54419	\$293.99	54420

Column Size	Tuscan Caps & Bases for Square DuraCast™ Columns			
	Cap		Base	
	Price	Stock #	Price	Stock #
8"	\$20.99	54304	\$31.99	54302
10"	\$28.99	54308	\$47.99	54306
12"	\$49.99	54312	\$73.99	54310
14"	\$86.99	54316	\$113.99	54314
16"	\$126.99	54320	\$156.99	54318

Cap & Base for Craftsman DuraCast™ Columns

Column Size	Cap		Base	
	Price	Stock #	Price	Stock #
10" x 5.5" x 66"	\$26.50	46361	\$47.60	46360
12" x 10" x 6' & 10'	\$48.30	46343	\$85.20	46342
16" x 9" x 58"	\$29.90	46353	\$130.20	46352
16" x 9" x 8'	\$29.90	46353	\$138.30	46356
16" x 9" x 6'	\$29.90	46353	\$138.30	46356

Split Charge for individual cap or base: add 20% to list price

Split Charge for special cuts: add 20% to list price

DuraLite® Columns Quick Facts

Key Features:

- Square: Plain or Recessed Panel
- Round Non-Tapered
- Lightweight
- Low Maintenance
- Can be Trimmed to Any Height
- Durable
- Decay Resistant
- Load Bearing
- Limited Lifetime Warranty

Caps & Base/Plinths for DuraLite® Fiberglass Columns



Tuscan Cap & Base/Plinth

DuraLite® Fiberglass Column Styles



Round Non-Tapered Plain

Square Non-Tapered Plain

Square Non-Tapered Recessed Panel (1)

Square Non-Tapered Recessed Panel (2)

Square Non-Tapered Recessed Panel (3)

About DuraLite® Columns:

- DuraLite® Fiberglass Columns are manufactured using a pultrusion technology and are composed of Fiberglass Reinforced Polymers (FRP).
- Available in the following designs: Square, Square Recessed Panel, or Round Non-Tapered.
- The DuraLite® Fiberglass Column Shaft runs floor to ceiling and the cap, bead, and base/plinth slide around the shaft. (Example: An 8" x 8" x 8' Fiberglass Column Shaft measures 8'). See Illustration 1
- All Cap and Base/Plinth sets are sold separately from the column shaft.
- DuraLite® Fiberglass Columns are load bearing provided that they are not split.
- All DuraLite® Fiberglass Columns can be cut to any overall length. They can be cut from the bottom or top since the shafts are non-tapered. DuraLite™ Recessed Panel columns are adjustable and can be cut to any overall length.
- DuraLite® Recessed Panel Fiberglass Columns include a top panel insert piece and a bottom panel insert piece that must be attached to the column shaft on each side. Each boxed column will include a total of 4 top panel insert pieces and 4 bottom panel insert pieces.

Options and Ordering Tips:

- Tuscan Cap and Base/Plinths are the standard components for DuraLite® Fiberglass Columns and are sold separately. Additional styles are also available. All Caps and Base/Plinths for DuraLite® Fiberglass Columns are non-vented.
- DuraLite® Fiberglass Columns are boxed individually. Caps and Base/Plinths are boxed separately from the column shaft in a cap and base/plinth set box.
- Available in a Plain or Recessed Panel Shaft.
- For DuraLite® Recessed Panel Columns, additional panel divider pieces can be purchased separately in a Panel Divider Kit to achieve a 2-panel or a 3-panel column. One Panel Divider Kit is needed to achieve a 2-panel column and two Panel Divider Kits are needed to achieve a 3-panel column.

Illustration 1

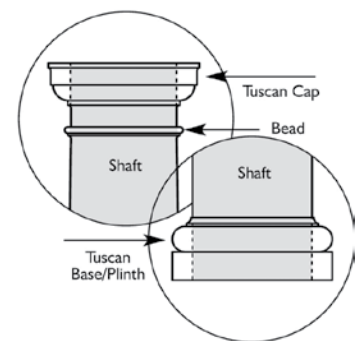

DuraLite® Fiberglass Columns

Fiberglass Column Installation Kit (Sold Separately)



To be used during installation to secure column shaft in place

Item #	Price
17040	\$10.60
Each Kit Includes: (4) Brackets (2 top; 2 bottom) (10) 2" Stainless Screws (10) Tapcon Screws	



DuraLite® Pallet Quantities	
Size	Per Pallet
6"	42
8"	40
10"	24
12"	12



Tuscan Cap & Base/Plinth

NOTE:

- All Cap and Base/Plinths are non-vented.
- All Cap and Base/Plinths are sold separately from the column.
- It is not recommended to split Synthetic Injection Molded (SIM) Cap and Base/Plinth sets for reassembly.
- Cap & Base/Plinths are manufactured from polyurethane or Synthetic Injection Molded (SIM).

NOTE:

- Bead is shipped with cap and base and applied in the field.
- SP = Square Plain Shaft
- RP = Recessed panel Shaft

DuraLite® Square Columns

Bottom Width X Height	Plain Shaft w/Neck Mould		Tuscan Cap & Base Set		Column Shaft & C/B Set	Wt. (lbs.)
	Price	Stock #	Price	Stock #	Plain	
6"x6'	\$214.00	80120606SP	\$45.00	8048060602	\$259.00	20
6"x8'	\$184.00	80120608SP	\$45.00	8048060602	\$229.00	22
6"x9'	\$204.00	80120609SP	\$45.00	8048060602	\$249.00	25
6"x10'	\$225.00	80120610SP	\$45.00	8048060602	\$270.00	28
<hr/>						
8"x6'	\$186.00	80120806SP	\$51.00	6048080802	\$237.00	30
8"x8'	\$236.00	80120808SP	\$51.00	6048080802	\$287.00	32
8"x9'	\$261.00	80120809SP	\$51.00	6048080802	\$312.00	37
8"x10'	\$290.00	80120810SP	\$51.00	6048080802	\$341.00	40
8"x12'	\$344.00	80120812SP	\$51.00	6048080802	\$395.00	48
<hr/>						
10"x6'	\$228.00	80121006SP	\$65.00	6048101002	\$293.00	39
10"x8'	\$290.00	80121008SP	\$65.00	6048101002	\$355.00	41
10"x9'	\$324.00	80121009SP	\$65.00	6048101002	\$389.00	46
10"x10'	\$357.00	80121010SP	\$65.00	6048101002	\$422.00	51
10"x12'	\$425.00	80121012SP	\$65.00	6048101002	\$490.00	65
<hr/>						
12"x6'	\$319.00	80121206SP	\$103.00	8048121202	\$422.00	47
12"x8'	\$407.00	80121208SP	\$103.00	8048121202	\$510.00	49
12"x9'	\$455.00	80121209SP	\$103.00	8048121202	\$558.00	55
12"x10'	\$503.00	80121210SP	\$103.00	8048121202	\$606.00	61
12"x12'	\$600.00	80121212SP	\$103.00	8048121202	\$703.00	73

Note: 8" and 10" Tuscan cap and base sets listed above are Synthetic Injection Molded (SIM).

- Does not include installation kit or PermaFlashing
- Available un-boxed; call for pricing

Tuscan Capitals and Bases for DuraLite® Square Columns

Column Size	Price	Cap		Base		Set	
		Stock #	Price	Stock #	Price	Stock #	
6"	\$18.00	8048060622	\$27.00	8048060632	\$45.00	8048060602	
8"	\$26.00	8048080822	\$40.00	8048080832	\$66.00	8048080802	
8" SIM		Full Set Only		Full Set Only		\$51.00	6048080802
10"	\$34.00	8048101022	\$52.00	8048101032	\$86.00	8048101002	
10" SIM		Full Set Only		Full Set Only		\$65.00	6048101002
12"	\$41.00	8048121222	\$62.00	8048121232	\$103.00	8048121202	

Note: Neck Mould included with Cap and Base Set

DuraLite® Round Columns

Bottom Width X Height	Shaft w/Neck Mould		Tuscan Cap & Base Set		Complete Column Shaft & C/B Set
	Price	Stock #	Price	Stock #	
8"x6'	\$145.75	80160806RD	\$73.50	52013	\$219.25
8"x8'	\$165.75	80160808RD	\$73.50	52013	\$239.25
8"x9'	\$185.75	80160809RD	\$73.50	52013	\$259.25
8"x10'	\$206.75	80160810RD	\$73.50	52013	\$280.25
<hr/>					
10"x6'	\$165.50	80161006RD	\$107.90	52016	\$273.40
10"x8'	\$200.50	80161008RD	\$107.90	52016	\$308.40
10"x9'	\$225.50	80161009RD	\$107.90	52016	\$333.40
10"x10'	\$246.50	80161010RD	\$107.90	52016	\$354.40
10"x12'	\$315.50	80161012RD	\$107.90	52016	\$423.40



DuraLite® Recessed Panel Columns					
Bottom Width X Height	Shaft w/Neck Mould		Tuscan Cap & Base Set		Complete Column Shaft & C/B Set Plain
	Price	Stock #	Price	Stock #	
8"x6'	\$240.00	80140806RP	\$51.00	6048080802	\$291.00
8"x8'	\$300.00	80140808RP	\$51.00	6048080802	\$351.00
8"x9'	\$332.00	80140809RP	\$51.00	6048080802	\$383.00
8"x10'	\$365.00	80140810RP	\$51.00	6048080802	\$416.00
8"x12'	\$430.00	80140812RP	\$51.00	6048080802	\$481.00
10"x6'	\$303.00	80141006RP	\$65.00	6048101002	\$368.00
10"x8'	\$379.00	80141008RP	\$65.00	6048101002	\$444.00
10"x9'	\$421.00	80141009RP	\$65.00	6048101002	\$486.00
10"x10'	\$463.00	80141010RP	\$65.00	6048101002	\$528.00
10"x12'	\$546.00	80141012RP	\$65.00	6048101002	\$611.00

Note: 8" and 10" Tuscan cap and base sets listed above are Synthetic Injection Molded (SIM).
 • Available un-boxed; call for pricing

• DuraLite® Split Columns are not available.

NOTE:

- Bead is shipped with cap and base and applied in the field.
- RP = Recessed Panel Shaft

Panel Divider Kits for DuraLite® Square Non-Tapered Recessed Panel Columns		
Kit Size	Item #	Price
8" Panel Divider Kit	80480808PK	\$29.00
10" Panel Divider Kit	80481010PK	\$40.00

NOTE: Each Panel Divider Kit includes (4) pieces. One Panel Kit is needed to achieve a 2-panel column and two Panel Divider Kits are needed to achieve a 3-panel column. Panel Divider Kits for achieving a 2-panel or 3-panel column are sold separately.

Panel Insert Kits for DuraLite® Square Non-Tapered Recessed Panel Columns		
Kit Size	Item #	Price
8" Panel Insert Kit	80480808PI	\$74.00
10" Panel Insert Kit	80481010PI	\$97.00

NOTE: Each Panel Insert Kit includes (8) pieces. (4) Panel Insert pieces are for the top and (4) Panel Insert pieces are for the bottom. (1 Kit included with each column)

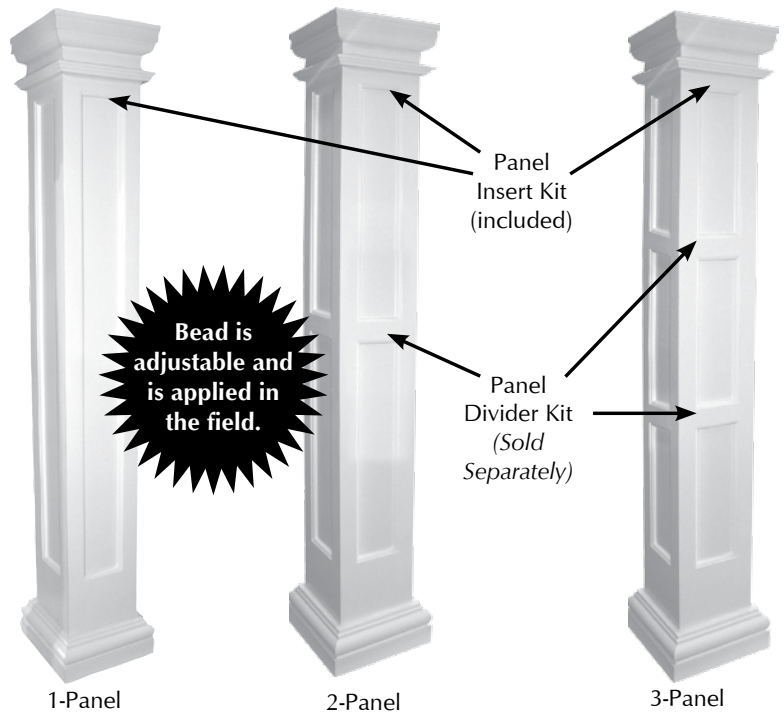

NOTE: Each DuraLite® Recessed Panel Column will include top panel insert pieces and bottom panel insert pieces that must be attached to the column shaft on each side. Each boxed column will include a total of (4) top panel insert pieces and (4) bottom panel insert pieces.

Plain (2 - L - Shaped Halves) PVC Square Columns

Width X Height	Complete Column Shaft & Ogee C/B		Complete Column Shaft and Standard C/B		Wt. (lbs.)	Per Pallet
	Price	Stock #	Price	Stock #		
6"x8'	\$247.00	85411	\$247.00	84311	27	24
6"x9'	\$272.00	85412	\$272.00	84312	30	24
6"x10'	\$284.00	85413	\$284.00	84313	33	24
8"x8'	\$291.50	85416	\$291.50	84316	34	20
8"x9'	\$318.00	85417	\$318.00	84320	38	20
8"x10'	\$329.00	85421	\$329.00	84321	43	20
10"x8'	\$372.00	85426	\$372.00	84326	41	16
10"x9'	\$404.00	85427	\$404.00	84327	46	16
10"x10'	\$417.00	85431	\$417.00	84331	52	16
12"x8'	\$371.00	85436	\$371.00	84336	49	9
12"x9'	\$419.00	85437	\$419.00	84337	55	9
12"x10'	\$432.00	85441	\$432.00	84341	61	9

Additional sizes and styles available. Call for quote.

Recessed (2 - L - Shaped Halves) Square PVC Columns

Width X Height	Shaft w/Neck Mould	Ogee Cap & Base	Complete Column Shaft and 5/8" C/B		Wt. (lbs.)	Per Pallet
	Price	Price	Price	Stock #		
6"x8'	Included	Included	\$440.00	84009	53	24
8"x8'	Included	Included	\$540.00	84016	68	20
8"x9'	Included	Included	\$595.00	84017	77	20
8"x10'	Included	Included	\$617.00	84021	85	20
10"x8'	Included	Included	\$680.00	84026	83	16
10"x9'	Included	Included	\$730.00	84027	93	16
10"x10'	Included	Included	\$770.00	84031	103	16
12"x8'	Included	Included	\$735.00	84036	97	9
12"x9'	Included	Included	\$796.00	84037	110	9
12"x10'	Included	Included	\$839.00	84041	122	9

Additional sizes and styles available. Call for quote.

Raised Panel (2 - L - Shaped Halves) Square PVC Columns

Width X Height	Shaft w/Neck Mould	Ogee Cap & Base	Complete Column Shaft and 5/8" C/B		Wt. (lbs.)	Per Pallet
	Price	Price	Price	Stock #		
8"x8'	Included	Included	\$475.00	84116	68	20
8"x9'	Included	Included	\$496.00	84117	77	20

Additional sizes and styles available. Call for quote.

Plain Craftsman (2 - L - Shaped Halves) PVC Columns						
Bottom Width X Top Width X Height	Shaft w/Neck Mould Price	Traditional Style Cap & Base Price	Complete Column Shaft and C/B Price	Stock #	Wt lbs	Per Pallet
12"x8"x48"	Included	Included	\$390.00	83128	48	6
12"x8"x54"	Included	Included	\$432.50	83130	51	6
12"x8"x60"	Included	Included	\$445.00	83132	68	6
12"x8"x66"	Included	Included	\$465.00	83134	77	6
12"x8"x72"	Included	Included	\$480.00	83136	85	6
12"x8"x96"	Included	Included	\$530.00	83138	102	6
16"x10"x54"	Included	Included	\$537.50	83142	62	4
16"x10"x60"	Included	Included	\$550.00	83144	83	4
16"x10"x66"	Included	Included	\$575.00	83146	93	4
16"x10"x72"	Included	Included	\$580.00	83148	103	4
16"x10"x84"	Included	Included	\$593.00	83149	114	4
16"x10"x96"	Included	Included	\$672.00	83150	124	4
16"x10"x108"	Included	Included	\$719.00	83151	136	4
16"x10"x120"	Included	Included	\$770.00	83152	148	4

Additional sizes and styles available. Call for quote.

Recessed Panel Craftsman (2 - L - Shaped Halves) PVC Columns						
Bottom Width X Top Width X Height	Shaft w/Neck Mould Price	Traditional Style Cap & Base Price	Complete Column Shaft and C/B Price	Stock #	Wt lbs	Per Pallet
12"x8"x60"	Included	Included	\$555.00	83332	68	6
12"x8"x72"	Included	Included	\$629.00	83336	85	6
12"x8"x96"	Included	Included	\$706.00	83338	102	6
16"x10"x60"	Included	Included	\$693.00	83344	83	4
16"x10"x72"	Included	Included	\$764.00	83348	103	0

Additional sizes and styles available. Call for quote.

Raised Panel Craftsman (2 - L - Shaped Halves) PVC Columns						
Bottom Width X Top Width X Height	Shaft w/Neck Mould Price	Traditional Style Cap & Base Price	Complete Column Shaft and C/B Price	Stock #	Wt lbs	Per Pallet
12"x8"x60"	Included	Included	\$477.00	83232	68	6
12"x8"x96"	Included	Included	\$572.00	83238	102	6

Additional sizes and styles available. Call for quote.

Recessed Panel Pedestal (2 - L - Shaped Halves) PVC Columns						
Bottom Width X Top Width X Height	Shaft w/Neck Mould Price	Traditional Style Cap & Base Price	Complete Column Shaft and C/B Price	Stock #	Wt lbs	Per Pallet
16"x16"x40"	Included	Included	\$631.00	83082	53	4

Additional sizes and styles available. Call for quote.

Raised Panel Pedestal (2 - L - Shaped Halves) PVC Columns						
Bottom Width X Top Width X Height	Shaft w/Neck Mould Price	Traditional Style Cap & Base Price	Complete Column Shaft and C/B Price	Stock #	Wt lbs	Per Pallet
16"x16"x40"	Included	Included	\$546.00	83102	53	4

Additional sizes and styles available. Call for quote.

Caps and Bases for PVC Columns

Polyurethane Ornamental Capitals List Pricing

Capital	6" Square		8" Square		10" Square		12" Square	
	Price	Stock #	Price	Stock #	Price	Stock #	Price	Stock #
Roman Ionic	\$161.99	77592	\$176.99	77621	\$225.99	77622	\$315.99	77623
Greek Ionic	\$161.99	77591	\$176.99	77641	\$225.99	77642	\$315.99	77643
Temple of the Winds*	\$225.99	77595	\$278.40	77601	\$521.20	77602	\$775.99	77603
Roman Corinthian*	\$388.99	77593	\$485.99	77631	\$775.99	77632	\$970.99	77633
Scamozzi	\$194.99	77594	\$211.99	77611	\$315.99	77612	\$444.99	77613

* Can not use with fluted or paneled square columns. Order a custom column and designate adjusted flute and panel dimensions.

- Polyurethane Caps and bases must be split: add 20% to list price.
- Adding an ornamental capital to a square column DOES NOT change the length of the column shaft. The ornamental capital simply slides over the shaft. Neck moulding can be applied or not.

Polyurethane Tuscan Caps & Bases for Square Columns Pricing

Column Size	Cap		Base	
	Price	Stock #	Price	Stock #
6"	\$20.99	54300	\$31.99	54298
8"	\$20.99	54304	\$31.99	54302
10"	\$28.99	54308	\$47.99	54306
12"	\$49.99	54312	\$73.99	54310

Polyurethane Caps and bases must be split.

Polyurethane Crown Cap List Pricing

Column Width	Cap Price	Stock #
6"	\$45.99	61061
8"	\$53.99	61062
10"	\$73.99	61063
12"	\$108.99	61064

Polyurethane Caps and bases must be split.

Polyurethane Attic Bases for Square Columns

Column Width	Torus		Plinth		Set	
	Price	Stock #	Price	Stock #	Price	Stock #
6"	\$43.99	54395	\$29.99	54397	\$72.99	54398
8"	\$46.99	54401	\$32.99	54403	\$78.99	54404
10"	\$69.99	54405	\$57.99	54407	\$126.99	54408
12"	\$84.99	54409	\$70.99	54411	\$154.99	54412
16"	\$143.99	54417	\$150.99	54419	\$293.99	54420

Polyurethane Caps and bases must be split

3/8" Cellular PVC Standard Style List Price

Column Width	Cap and Base Set Price	Stock #
6"	\$78.80	61040
8"	\$83.80	61042
10"	\$97.50	61046
12"	\$102.50	61048

5/8" Cellular PVC Ogee Style List Price

Column Width	Cap and Base Set Price	Stock #
6"	\$78.80	84060
8"	\$83.80	84062
10"	\$97.50	84064
12"	\$102.50	84066

Cellular PVC Traditional Style List Price

Column Width	Cap and Base Set Price	Stock #
6"	\$105.00	84280
8"	\$113.80	84281
10"	\$123.80	84282
12"	\$126.30	84283

- Split Charge for individual cap or base: add 20% to list price
- Split Charge for special cuts: add 20% to list price

STOCK #	Description & Nominal Dimensions	Actual Inside Dimensions	Actual Outside Dimensions	Suggested Retail Price Each
WNS485	Wrap N' Snap Post Wrap 4"x4"x8.5'	4"x4"x8.5'	4 3/4"x4 3/4"x8.5'	\$109.99
WNS410	Wrap N' Snap Post Wrap 4"x4"x10'	4"x4"x10'	4 3/4"x4 3/4"x10'	\$129.99
WNS685	Wrap N' Snap Post Wrap 6"x6"x8.5'	5 3/4"x5 3/4"x8.5'	6 3/4"x6 3/4"x8.5'	\$159.99
WNS610	Wrap N' Snap Post Wrap 6"x6"x10'	5 3/4"x5 3/4"x10'	6 3/4"x6 3/4"x10'	\$194.99
WNS885	Wrap N' Snap Post Wrap 8"x8"x8.5'	8 3/4"x8 3/4"x8.5'	9 1/2"x9 1/2"x8.5'	\$224.99
WNS810	Wrap N' Snap Post Wrap 8"x8"x10'	8 3/4"x8 3/4"x10'	9 1/2"x9 1/2"x10'	\$269.99
WNS1085	Wrap N' Snap Post Wrap 10"x10"x8.5'	10 3/4"x10 3/4"x8.5'	11 1/2"x11 1/2"x8.5'	\$279.99
WNS1010	Wrap N' Snap Post Wrap 10"x10"x10'	10 3/4"x10 3/4"x10'	11 1/2"x11 1/2"x10'	\$334.99

Wrap N' Snap Cap and Base Trim Kits

STOCK #	Description & Nominal Dimensions	Actual Inside Dimensions	Actual Outside Dimensions	Suggested Retail Price Each
TKCOL44	4" Colonial Trim Kit	4 3/4"	N/A	\$44.99
TKWIL44	4" Williamsburg Trim Kit	4 3/4"	N/A	\$69.99
TKARC44	4" Arcadia Trim Kit	4 3/4"	N/A	\$74.99
TKCOL66	6" Colonial Trim Kit	6 3/4"	N/A	\$59.99
TKWIL66	6" Williamsburg Trim Kit	6 3/4"	N/A	\$84.99
TKARC66	6" Arcadia Trim Kit	6 3/4"	N/A	\$94.99
TKCOL88	8" Colonial Trim Kit	9 1/2"	N/A	\$74.99
TKWIL88	8" Williamsburg Trim Kit	9 1/2"	N/A	\$109.99
TKARC88	8" Arcadia Trim Kit	9 1/2"	N/A	\$134.99
TKCOL1010	10" Colonial Trim Kit	11 1/2"	N/A	\$89.99
TKWIL1010	10" Williamsburg Trim Kit	11 1/2"	N/A	\$129.99
TKARC1010	10" Arcadia Trim Kit	11 1/2"	N/A	\$159.99
WNS4CAPB	Wrap N' Snap 4" Post Cap, Belmont	4 3/4"	N/A	\$24.99
WNS4CAPW	Wrap N' Snap 4" Post Cap, Windsor	4 3/4"	N/A	\$44.99
WNS6CAPB	Wrap N' Snap 6" Post Cap, Belmont	6 3/4"	N/A	\$34.99
WNS6CAPW	Wrap N' Snap 6" Post Cap, Windsor	6 3/4"	N/A	\$59.99

Wrap N' Snap Accessories

STOCK #	Description & Nominal Dimensions	Actual Inside Dimensions	Actual Outside Dimensions	Suggested Retail Price Each
WNSDT100	Moulding Connector Dove Tails (100)	N/A	N/A	\$29.99
WNSA8	PVC Adhesive, 8 oz. Tube	N/A	N/A	\$19.99

• There could be a variance of $\pm 1/8"$ on all measurements.

Architectural Wood Columns

All architectural wood columns are custom, made to order. Each wood column is formed of nominal 4" wide staves and interlocked together with a tongue and groove stave construction. The staves are glued with the highest quality Type 1 water-resistant glue and kept under pressure for a minimum of eighteen hours to ensure a proper adhesion. Unless specified otherwise all architectural wood columns have a true architectural taper. The bottom one third of the shaft is straight and the top two thirds of the shaft is tapered. All diameters or widths are actual (not nominal) and all overall lengths are manufactured to your exact specified requirements.

It is recommended to use western red cedar or redwood for exterior applications. These species are naturally weather resistant and immune to decay and insect infestation. Pine or poplar may be used for interior use. We also offer a large selection of stain grade columns. Mahogany, maple, oak, and cherry are the most common species; however, other stain grade wood species as well as exotic hardwoods are also available. All columns used for exterior use have an interior asphalt coating applied to the inside of the shaft. Columns that are to be painted are primed with two to three coats of primer after they are turned and then sanded in between each coat of primer to provide an excellent surface for your topcoat.

Columns may be plain or fluted with the flutes being either Ionic or Doric design. Since all architectural wood columns are custom, we can manufacture the shafts, caps, and bases to your exact specifications. Whether you are looking for an exact overall length or a specific diameter, we can manufacture exactly what you are looking for. A large selection of caps and bases are available to complement any design. Choose from Tuscan, Greek Doric, Roman Doric, or Attic to name a few. If you are looking for something more ornate, we have a complete line of ornamental capitals to crown the top of your column while adding a stylish flourish. Columns may serve as a structural support or merely as a decorative accent. They are available in round or square and can be split to the following plan types:

Splitting Options

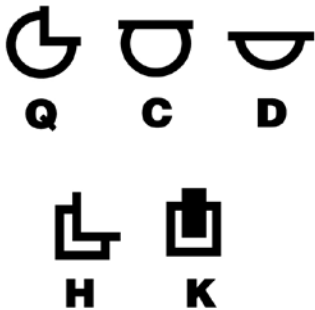

Quoting Requirements:

- 1.) Quantity required
- 2.) Design (Tuscan, Roman Ionic, Greek Doric, Roman Doric, or Custom)
- 3.) Plan type
- 4.) Bottom diameter/width and overall length
- 5.) Exterior or interior application
- 6.) Stain Grade or Paint Grade
- 7.) Wood species
- 8.) Plain or fluted. If fluted, Ionic flute, or Doric flute?
- 9.) If columns are split for reassembly, specify shape and size of structural support
- 10.) Will columns match an existing column?

Round Wood Columns List Pricing

Bottom Diameter X Height	Plain Shaft		Fluted Shaft		Cap & Base Set		Complete Column Shaft & C/B		Split Split Shaft Plain		Split Shaft Fluted		Cap & Base Set		Wt. (lbs.)	Per Pallet
	Price	Stock #	Price	Stock #	Price	Stock #	Plain	Fluted	Price	Stock #	Price	Stock #	Price	Stock #		
6" x 8'	\$170.80	00011	\$225.40	00021	\$42.90	13000	\$213.70	\$268.30	\$214.30	00011S	\$281.40	00021S	\$56.80	13000S	22	36
6" x 10'	\$235.30	00031	\$302.40	00041	\$42.90	13000	\$278.20	\$345.30	\$294.00	00031S	\$378.00	00041S	\$56.80	13000S	23	36
8" x 8'	\$199.40	00051	\$252.00	00061	\$52.00	13030	\$251.40	\$304.00	\$260.40	00051S	\$315.00	00061S	\$68.50	13030S	31	36
8" x 8**	\$204.40	00052	\$266.00	00062	\$52.00	13030	\$256.40	\$318.00	\$278.60	00052S	\$333.30	00062S	\$68.50	13030S	31	36
8" x 10'	\$259.00	00071	\$308.00	00081	\$52.00	13030	\$311.00	\$360.00	\$323.40	00071S	\$385.00	00081S	\$68.50	13030S	38	36
8" x 12'	\$434.00	00091	\$511.00	00101	\$52.00	13030	\$486.00	\$563.00	\$543.30	00091S	\$638.40	00101S	\$68.50	13030S	43	36
10" x 8'	\$266.00	00111	\$319.30	00121	\$76.60	13060	\$342.60	\$395.90	\$333.30	00111S	\$399.00	00121S	\$100.30	13060S	40	24
10" x 10'	\$319.30	00131	\$371.00	00141	\$76.60	13060	\$395.90	\$447.60	\$399.00	00131S	\$463.40	00141S	\$100.30	13060S	54	24
10" x 12'	\$448.00	00151	\$567.00	00161	\$76.60	13060	\$524.60	\$643.60	\$560.00	00151S	\$708.40	00161S	\$100.30	13060S	67	24
12" x 8'	\$324.80	00171	\$418.60	00181	\$99.40	13090	\$424.20	\$518.00	\$406.00	00171S	\$523.60	00181S	\$130.30	13090S	50	16
12" x 10'	\$464.80	00191	\$546.00	00201	\$99.40	13090	\$564.20	\$645.40	\$581.00	00191S	\$683.30	00201S	\$130.30	13090S	57	16
12" x 12'	\$628.60	00211	\$746.30	00221	\$99.40	13090	\$728.00	\$845.70	\$785.40	00211S	\$932.40	00221S	\$130.30	13090S	72	16

*Primed

- Additional sizes available, call for quote.
- Call for quote on all custom architectural wood products.

Features

- 1 year warranty
- Stock pine columns are manufactured using paint-grade, finger-jointed pine.
- Wood columns can be painted any color.
- Round Wood columns are load bearing.

For individual cap and base pricing, refer to pages 31 and 32.

What You Need To Know

- A complete column consists of shaft, cap, and base.
- Cap and base fit on top and bottom of column insulating the column from the elements.
- Split columns are not load bearing.
- For transportation purposes, small sections of split columns are left partially intact.
- High quality exterior oil based primer and top coats must be used.
- Storage of columns must be in a dry, well-ventilated area.
- For exterior applications: Coat inside of column shaft with a nonfibrous asphaltum-type roof coating. Application must reach a minimum 48" up the inside bottom of the column shaft.
- Wood columns require ventilation at the top and bottom. Please refer to installation instructions.
- Failure to adhere to installation instructions voids the warranty.
- Custom fluting available.
- When ordering a cap and base set, the Standard model is shipped unless otherwise specified.

**SKU # 00052 and 00062
ARE FACTORY PRIMED WOOD COLUMNS.**

**12" x 14' Columns and Larger are Available.
Call for Quote.**

Ornamental Capitals for Round Wood List Pricing

Capital	6" Round		8" Round		10" Round		12" Round	
	Price	Stock #	Price	Stock #	Price	Stock #	Price	Stock #
Roman Ionic	\$320.10	01510	\$176.99	76911	\$225.99	76912	\$315.99	76913
Greek Ionic	\$320.10	02010	\$157.99	76901	\$200.99	76902	\$280.99	76903
Temple of the Winds	\$416.00	01910	\$250.99	76941	\$331.99	76942	\$485.99	76943
Roman Corinthian	\$486.20	01810	\$324.99	76921	\$469.99	76922	\$624.99	76923
Scamozzi	\$377.90	01610	\$187.99	76931	\$280.99	76932	\$394.99	76933

Features

- Molded from polyurethane resin or custom manufactured using plaster composite where noted.
- Lightweight for easy installation.
- Weather, rot, and bug-proof.

What You Need To Know

- All styles shown available for round.
- 8" - 12" Ornamental Capitals for Round wood columns are load bearing.

For Ornamental Capital Larger than the 12" – Call for Quote.



Roman Ionic



Temple of the Winds



Scamozzi

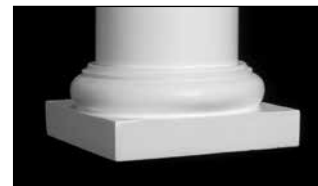

Tuscan Base



Greek Ionic



Roman Corinthian



Tuscan Cap



Attic Base

Add 20% to all split caps and bases.

8" - 12"

Load Bearing Ornamental Capitals for ROUND Wood Columns

Adding a load bearing ornamental capital to a round wood column will lengthen or shorten the overall height of the column depending on the height of the capital. Subtract the cut at bead dimension (from the dimensions chart in the products brochure) and add the height of the ornamental capital +/- 1/4" for overall column height.

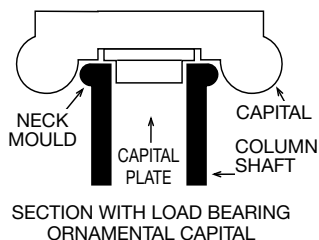

6", 14" - 30"

Ornamental Capitals for ROUND Wood Columns

Adding an ornamental capital to a round or square wood column will lengthen or shorten the overall height of the column depending on the height of the capital. Subtract the cut at bead dimension (from dimension chart in the products brochure) and add the height of the ornamental capital +/- 1/4" for overall column height.

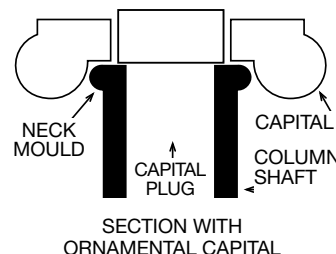

Cap and Base Options for Round Wood Columns List Pricing

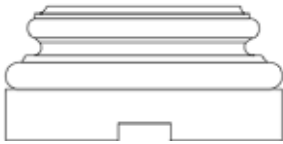

Attic Base

Poly Attic Base for Round Wood Columns							
Column Size	Torus		Plinth		Set		
	Price	Stock #	Price	Stock #	Price	Stock #	
8"	\$51.70	54092	\$35.60	14030	\$87.30	53110	
10"	\$77.50	54112	\$62.90	14070	\$140.40	53120	
12"	\$93.80	54132	\$77.50	14110	\$171.30	53130	



Classic Base

Classic Poly Caps & Bases for Round Wood Columns								
Column Size	Cap		Torus		Plinth		Cap & Base Set	
	Price	Stock #	Price	Stock #	Price	Stock #	Price	Stock #
8"	\$16.90	13040	\$45.30	14020	\$35.60	14030	\$98.70	14000
10"	\$33.90	14050	\$46.70	14060	\$62.90	14070	\$143.60	14040
12"	\$46.70	14090	\$58.20	14100	\$77.50	14110	\$182.30	14080



Standard Base

Standard Wood Cap & Base for Round Wood Column		
Column Size	Cap & Base Set Price	Stock #
6"	\$84.20	12000
8"	\$100.10	12050
10"	\$145.10	12100
12"	\$207.50	12160

Standard Poly Caps & Bases for Round Wood Columns				
Column Size	Cap		Base	
	Price (each)	Stock #	Price (each)	Stock #
6"	\$13.80	13010	\$29.10	13020
8"	\$16.90	13040	\$35.30	13050
10"	\$26.00	13070	\$50.60	13080
12"	\$35.30	13100	\$64.10	13110

Other sizes available. Call For Quote.

Cast Aluminum Plinths			
Column Size	Plinth Size	List	
		Price	Stock #
6"	7-1/4"x7-1/4"x1-3/4"	\$36.50	01100
8"	9-1/4"x9-1/4"x1-3/4"	\$41.20	01110
10"	11-1/4"x11-1/4"x1-3/4"	\$50.40	01120
12"	13-1/4"x13-1/4"x1-3/4"	\$68.60	01130
12" o/s	16"x16"x3"	\$170.20	01140

Larger Caps and Bases are Available. Call for Quote.

OTHER SIZES OF WOOD CAPS AND BASES ARE AVAILABLE. IF NOT LISTED HERE, CALL FOR QUOTE.

SPLITTING CHARGE – ADD 20% • UNVENTED CAP OR BASE – ADD 20%

Aluminum Columns

Round White Fluted Aluminum Column

Bottom Width X Height	Price	Fluted Shaft		Fluted Shaft and Cap and Base		Cap & Base*		Wt. (lbs.)
		Price	Stock #	Price	Stock #	Price	Stock #	
6"x8'	\$107.27		RD0608WHT	\$128.97	RD0608WHTW	\$21.70	RDSTD06WHT	14
6"x9'	\$123.51		RD0609WHT	\$145.21	RD0609WHTW	\$21.70	RDSTD06WHT	15.75
6"x10'	\$137.13		RD0610WHT	\$158.83	RD0610WHTW	\$21.70	RDSTD06WHT	17.5
8"x8'	\$141.91		RD0808WHT	\$170.51	RD0808WHTW	\$28.60	RDSTD08WHT	19
8"x9'	\$159.68		RD0809WHT	\$188.28	RD0809WHTW	\$28.60	RDSTD08WHT	21.38
8"x10'	\$177.45		RD0810WHT	\$206.05	RD0810WHTW	\$28.60	RDSTD08WHT	23.75
10"x8'	\$174.34		RD1008WHT	\$221.53	RD1008WHTW	\$47.19	RDSTD10WHT	24
10"x9'	\$196.05		RD1009WHT	\$243.24	RD1009WHTW	\$47.19	RDSTD10WHT	27
10"x10'	\$217.75		RD1010WHT	\$264.95	RD1010WHTW	\$47.19	RDSTD10WHT	30

Square White Fluted Aluminum Column

Bottom Width X Height	Price	Fluted Shaft		Fluted Shaft and Cap and Base		Cap & Base*		Wt. (lbs.)
		Price	Stock #	Price	Stock #	Price	Stock #	
4"x8'	\$92.40		SQ0408WHT	N/A	N/A	\$25.07	SQSTD04WHT	12.5
4"x10'	\$115.90		SQ0410WHT	N/A	N/A	\$25.07	SQSTD04WHT	15.5
6"x8'	\$123.66		SQ0608WHT	\$159.66	SQ0608WHTW	\$36.00	SQSTD06WHT	17
6"x9'	\$139.16		SQ0609WHT	\$175.16	SQ0609WHTW	\$36.00	SQSTD06WHT	19.2
6"x10'	\$154.65		SQ0610WHT	\$190.65	SQ0610WHTW	\$36.00	SQSTD06WHT	21.25
8"x8'	\$172.67		SQ0808WHT	\$225.85	SQ0808WHTW	\$53.18	SQSTD08WHT	22
8"x9'	\$194.25		SQ0809WHT	\$247.43	SQ0809WHTW	\$53.18	SQSTD08WHT	24.75
8"x10'	\$215.86		SQ0810WHT	\$269.04	SQ0810WHTW	\$53.18	SQSTD08WHT	27.5
10"x8'	\$325.69		SQ1008WHT	N/A	N/A	\$79.92	SQSTD10WHT	37
10"x9'	\$366.41		SQ1009WHT	N/A	N/A	\$79.92	SQSTD10WHT	42
10"x10'	\$407.13		SQ1010WHT	N/A	N/A	\$79.92	SQSTD10WHT	46.25

Square Textured Legend Aluminum Column

Bottom Width X Height	Price	Shaft Stock #	Shaft and Cap and Base		Price	Cap & Base*		Wt. (lbs.)
			Price	Stock #		Price	Stock #	
6"x8'	\$161.10	BX0608TXT	N/A	N/A	\$32.93		SL06CBSET	23
6"x9'	\$183.90	BX0609TXT	N/A	N/A	\$32.93		SL06CBSET	26.25
6"x10'	\$201.65	BX0610TXT	N/A	N/A	\$32.93		SL06CBSET	29
8"x8'	\$236.07	BX0808TXT	N/A	N/A	\$38.16		SL08CBSET	32.75
8"x9'	\$279.03	BX0809TXT	N/A	N/A	\$38.16		SL08CBSET	36.5
8"x10'	\$312.07	BX0810TXT	N/A	N/A	\$38.16		SL08CBSET	40.25

Square Plain Textured Elite Aluminum Column

Bottom Width X Height	Price	Shaft		Shaft and Cap and Base		Cap & Base*		Wt. (lbs.)
		Stock #		Price	Stock #	Price	Stock #	
6"x8'	\$161.10	BX0608TXT		N/A	N/A	\$57.40	SE06CABSET	24.5
6"x9'	\$183.90	BX0609TXT		N/A	N/A	\$57.40	SE06CABSET	27
6"x10'	\$201.65	BX0610TXT		N/A	N/A	\$57.40	SE06CABSET	29.75
8"x8'	\$236.07	BX0808TXT		N/A	N/A	\$68.56	SE08CABSET	34.25
8"x9'	\$279.03	BX0809TXT		N/A	N/A	\$68.56	SE08CABSET	38
8X10'	\$312.07	BX0810TXT		N/A	N/A	\$68.56	SE08CABSET	41.75

Square White Heritage Aluminum Column

Bottom Width X Height	Price	Shaft		Shaft and Cap and Base		Cap & Base*		Wt. (lbs.)
		Stock #		Price	Stock #	Price	Stock #	
6"x8'	\$197.97	HP0608WHT		N/A	N/A	\$36.00	SQSTD06WHT	26.75
6"x9'	\$223.01	HP0609WHT		N/A	N/A	\$36.00	SQSTD06WHT	29.75
6"x10'	\$246.14	HP0816WHT		N/A	N/A	\$36.00	SQSTD06WHT	32.75
8"x8'	\$275.71	HP0808WHT		N/A	N/A	\$53.18	SQSTD08WHT	36.5
8"x9'	\$310.06	HP0809WHT		N/A	N/A	\$53.18	SQSTD08WHT	40.5
8X10'	\$344.62	HP0810WHT		N/A	N/A	\$53.18	SQSTD08WHT	44.5

Round & Square Aluminum Split Cap & Base Set

Diameter	Split Cap and Base Set	
	Price	Stock #
6" RD	\$40.75	RDSTD06WHTS
8" RD	\$47.65	RDSTD08WHTS
10" RD	\$66.24	RDSTD10WHTS
4" SQ	\$44.12	SQSTD04WHTS
6" SQ	\$55.05	SQSTD06WHTS
8" SQ	\$72.23	SQSTD08WHTS
10" SQ	\$98.97	SQSTD10WHTS

Square Fluted Vinyl Post Wrap

Bottom Diameter X Height	Price	Stock #	UOM
4"x120"	\$106.29	95004	1
6"x102"	\$113.09	95001	1
6"x120"	\$132.00	95002	1
4"x102"	\$404.49	95008	5 pack
4"x120"	\$483.15	95009	5 pack
6"x102"	\$411.24	95006	4 pack
6"x120"	\$480.00	95007	4 pack
6" Adj Collar	\$11.62	95002	1
6" Adj Collar	\$211.24	95010	20 pack

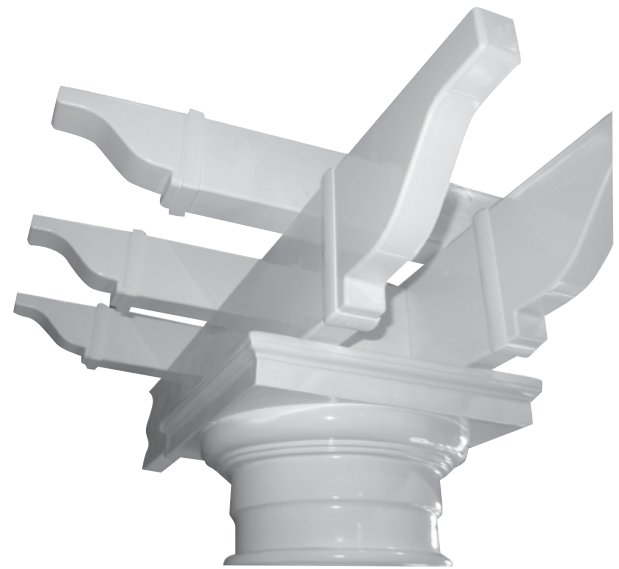
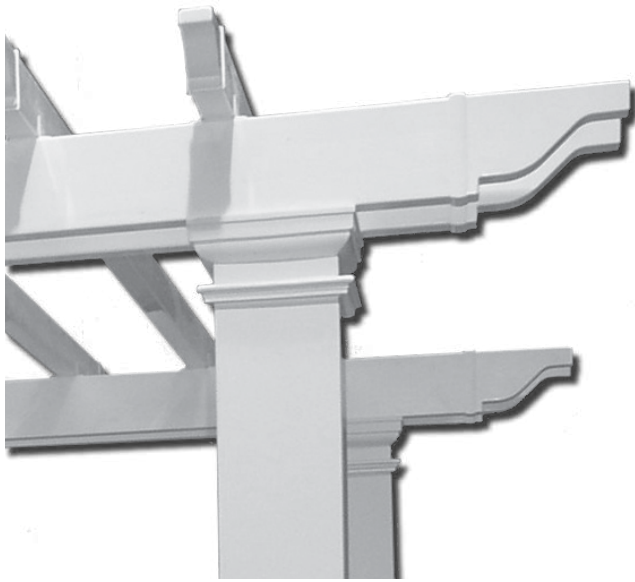

Reinforced PVC Pergolas

Stock #	Item	List Price Each
87043	8' Standard Pergola Kit	\$8,070.00
87044	8' Premium Pergola Kit	\$9,817.50
87045	10' Standard Pergola Kit	\$10,290.00
87046	10' Premium Pergola Kit	\$13,263.80

Fiberglass Pergolas

Stock #	Item	List Price Each
D920001	12"x12' Pergola Kit Rd Pul NT	\$8,510.99
D920011	14"x14' Pergola Kit Rd Pul NT	\$9,723.99
D920021	16"x16' Pergola Kit Rd Pul NT	\$11,296.99
D920101	12"x12' Pergola Kit Sq Pul NT	\$8,436.99
D920111	14"x12' Pergola Kit Sq Pul NT	\$10,009.99
D920121	16"x16' Pergola Kit Sq Pul NT	\$11,582.99
D900001	Rd Wind Load/ Deck Plate 8" Columns	\$214.99
D900003	Rd Wind Load/ Deck Plate 10" Columns	\$243.99
D900002	Sq Wind Load/ Deck Plate 8" Columns	\$228.99
D900004	Sq Wind Load/ Deck Plate 10" Columns	\$257.99

Economy Hollow-Body Vinyl Pergolas

Stock #	Item	List Price Each
PERGKT0808	8' Vinyl Pergola Kit	\$5,620.40
PERGKT1010	10' Vinyl Pergola Kit	\$5,958.40

Custom pergolas, arbors, and trellises available. Call for quote!

- Standard pergola - Rafters on 24" centers
- Premium Pergola - Rafters on 12" centers
- Includes complete installation kit
- Includes 4 - 10" x 8' round DuraCast™ columns

Porch and Lamp Posts

Item	Size	List Price	Stock #	Splitting Charge	Weight (lbs)	Pallet Quantities	Load Bearing
Colonial	5" x 5" x 8'	\$151.10	71001	\$14.50	17	50 or 100	1300
Colonial	5" x 5" x 9'	\$174.60	71003	\$14.50	18	50 or 100	1300
Colonial	6" x 6" x 8'	\$210.60	71005	\$14.50	32	36 or 72	5000
Colonial	6" x 6" x 9'	\$238.30	71007	\$14.50	33	36 or 72	5000
Chamfered	6" x 6" x 8'	\$227.60	71009	\$14.50	20	28 or 56	5000
Square	5" x 5" x 8'	\$218.90	71012	\$14.50	20	45 or 90	5000
Square	5" x 5" x 9'	\$243.80	71014	\$14.50	25	45 or 90	5000
Square	5" x 5" x 10'	\$267.50	71016	\$14.50	30	45 or 90	5000
Synthetic Lamp Post		\$142.80	WLP5X8	N/A	15	28 or 49	N/A
Chamfered Lamp Post		\$227.60	82001	N/A	20	28 or 56	N/A

- Posts may be split for use as pilasters but are not recommended for re-assembly. Split Porch Posts have no pipe or foam
- All sizes are nominal • Add \$14.50 List to Split All Posts • Nominal 5"=4-1/4" • 6"= 5-1/4"

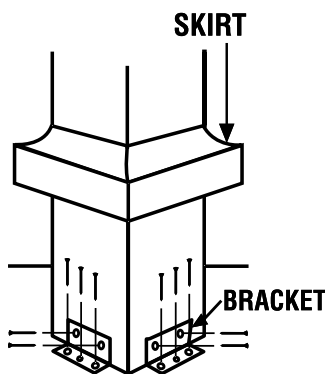
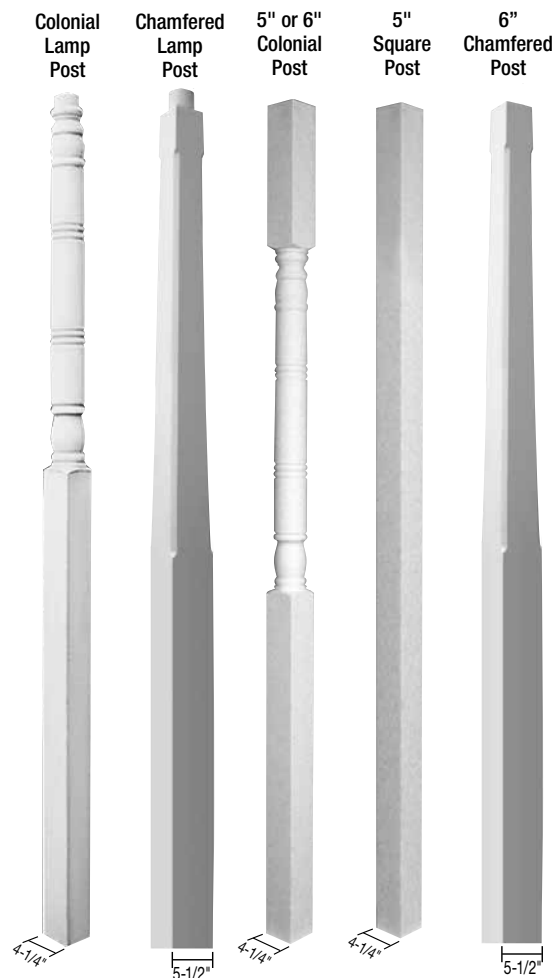

OPTIONAL: Fastening Kits

Each kit comes complete with skirt, brackets, and TapCon screws for wood or concrete substrates. Available for all synthetic post styles.

Fastening Kits (Sold Separately)

Size	List Price	Stock #
5" Colonial	\$27.40	08001
6" Colonial	\$30.50	08002
Square	\$26.70	08006

Includes 4 brackets, 1 skirt, and all hardware necessary to attach post to surface structure. To prevent lateral movement only.

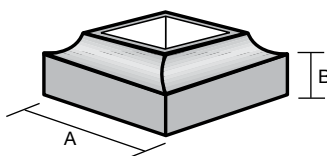

Skirt Only (Sold Separately)

Size	List Price	Stock #	A	B
5" Colonial	\$19.90	08003	6-1/2"	1-1/2"
6" Colonial	\$19.90	08004	7-7/8"	1-9/16"
Chamfered	\$30.50	08007	7-13/16"	1-1/2"
Square	\$19.10	08005	6-1/2"	1-1/2"

NOTE: All sizes are nominal.

- Posts may be split for pilaster but are not recommended for reassembly.
- Split posts are non load-bearing and have no pipe or foam.

Quick Facts

Key Features:

- Five Styles Available
- Precise Detail
- Never Needs Painting (Can Be Painted)
- Virtually Maintenance Free
- UV Protected
- Load-Bearing with Structural Metal Insert (Excludes Lamp Posts)
- Fasteners Included
- Optional Fastening Kits Available (Skirt, Brackets and Screws)
- 25 Year Warranty

Synthetic Post Fastener

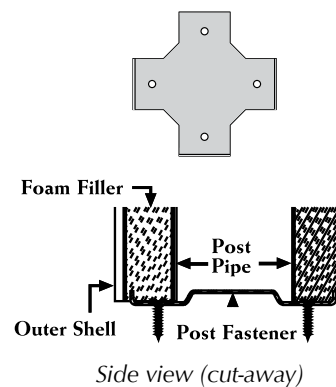

Square Post Fastener

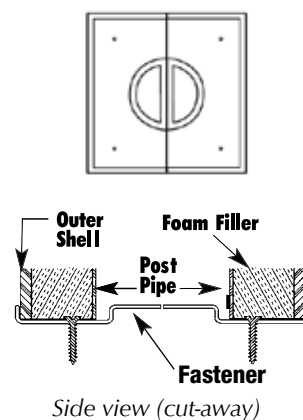

Dixie Synthetic Posts – Two (2) post fasteners are shipped with each post.

Wood Porch Posts

Wood Porch Posts Quick Facts

Key Features:

- Manufactured From Finger-Jointed Pine
- Load Bearing
- One Year Limited Warranty

About Wood Porch Posts:

- Wood Porch Posts are manufactured from Paint-Grade, finger-jointed pine and laminated.
- Aluminum Plinths are sold separately from the Wood Porch Posts.
- Wood Porch Posts are load bearing provided that they are not split.
- Wood Porch Posts must be stored, primed and painted according to manufacturer's instructions for the one year limited warranty to be valid. Aluminum Plinths MUST be used for all exterior applications

Options:

- Aluminum Plinths available (sold separately).
- Wood Porch Posts can be split in half for pilaster application. Split posts are non load-bearing.

Ordering Tips:

- Aluminum Plinths are sold separately from the Wood Porch Posts.

Wood Porch Posts						
STYLE # 100 (Primed)						
Size	8'		9'		10'	
	Price	Stock #	Price	Stock #	Price	Stock #

4"	\$90.10	02111	\$109.50	02141	\$138.10	02171
5"	\$127.30	02121	\$169.10	02151	\$199.50	02181
6"	\$161.00	02131	\$220.60	02161	\$255.40	02191

NOTE:

- All sizes of Colonial Wood Porch Posts are primed. Price includes priming.

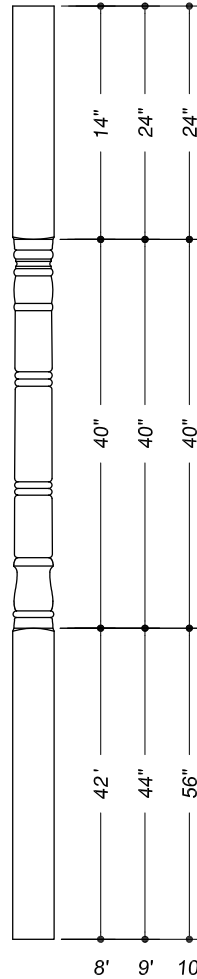

Colonial

Nominal 5" = 4-1/4" 6" = 5-1/4"

Quick Mount Post Fastener

Size	List price	Stock #
4"	\$9.00	17004
5"	\$9.20	17005
6"	\$12.00	17006

Aluminum Plinth

Size	List price	Stock #
4"	\$5.70	01070
5"	\$6.60	01080
6"	\$7.40	01090



Aluminum Plinth



6" Balustrade System

	Item	Length	Stock #	Carton Qty	Wt. (lbs.)	List Price Each
	Top Rail	8'	57021	1	15	\$376.99
	Top Rail	10'	57022	1	15	\$421.99
	Top Rail	12'	57023	1	19	\$467.99
	Bottom Rail	8'	57024	1	19	\$376.99
	Bottom Rail	10'	57025	1	22	\$421.99
	Bottom Rail	12'	57026	1	23	\$467.99
Square	3" Square Baluster	3" x 26 1/2"	58029	1	3	\$139.99
	3" Square Extended Baluster	3" x 32 7/8"	58030	1	4	\$148.99
Edinburgh	3" Baluster	3" x 20"	58031	1	2	\$126.99
	3" Extended Baluster	3" x 33-5/8"	58032	1	4	\$158.99
	3" Baluster	3" x 28"	58036	1	3	\$137.99
Wessex	3-3/8" Baluster	3-3/8" x 24"	58033	1	3	\$125.99
	3-3/8" Baluster	3-3/8" x 26-1/2"	58034	1	3	\$129.99
	3-3/8" Extended Baluster	3-3/8" x 32-7/8"	58035	1	4	\$142.99
Windsor	3-1/2" Baluster	3-1/2" x 32-1/2"	58037	1	3	\$150.99
	3-1/2" Extended Baluster	3-1/2" x 38"	58038	1	4	\$174.99
Wales	3-1/2" Baluster	3-1/2" x 29"	58061	1	3	\$140.99
	3-1/2" Baluster	3-1/2" x 31"	58062	1	3	\$156.99
	3-1/2" Extended Baluster	3-1/2" x 36"	58063	1	4	\$174.99
	Pyramid Cap	3"	57085	1	2	\$76.99
	Flat Cap	1-5/8"	57086	1	2	\$64.99
	Ball Top	8-1/4"	57087	1	2	\$102.99
	Five Sided Pyramid Cap	3"	57083	1	4	\$85.99
	Newel	48"	57088	1	29	\$285.99
	Five Sided Angle Newel	48"	57084	1	43	\$417.99
	Panel/Corner Newel	48"	57089	1	31	\$373.99
	Support Block	3"	58013	1	1	\$30.99
	Rail Kit	N/A	58001	1	1	\$36.99
	Newel Kit	N/A	58003	1	6	\$96.99
	Rail Kit for Five Sided Newel	N/A	58002	1	1	\$58.99

Balustrade Quick Facts

Key Features:

- Manufactured From High-Density Polyurethane
- Low Maintenance
- Durable
- Decay Resistant
- Primed White (Ready to Paint)
- Easy to Install
- Curved Radius Rail Styles Available
- 25 Year Limited Warranty

About Balustrade Systems:

- Balustrade systems are manufactured from a high-density polyurethane and primed white (ready to paint).
- The space between the bottom rail and substrate should not be more than 2".

Options & Ordering Tips:

- One rail hardware kit is required per each top and bottom rail section.
- When ordering a ball top, also order a flat cap for proper installation.
- All components are sold separately (Top Rail, Bottom Rail, Balusters, Caps, Tops, Newels, Support Blocks, Rail Kits, and Newel Kits).

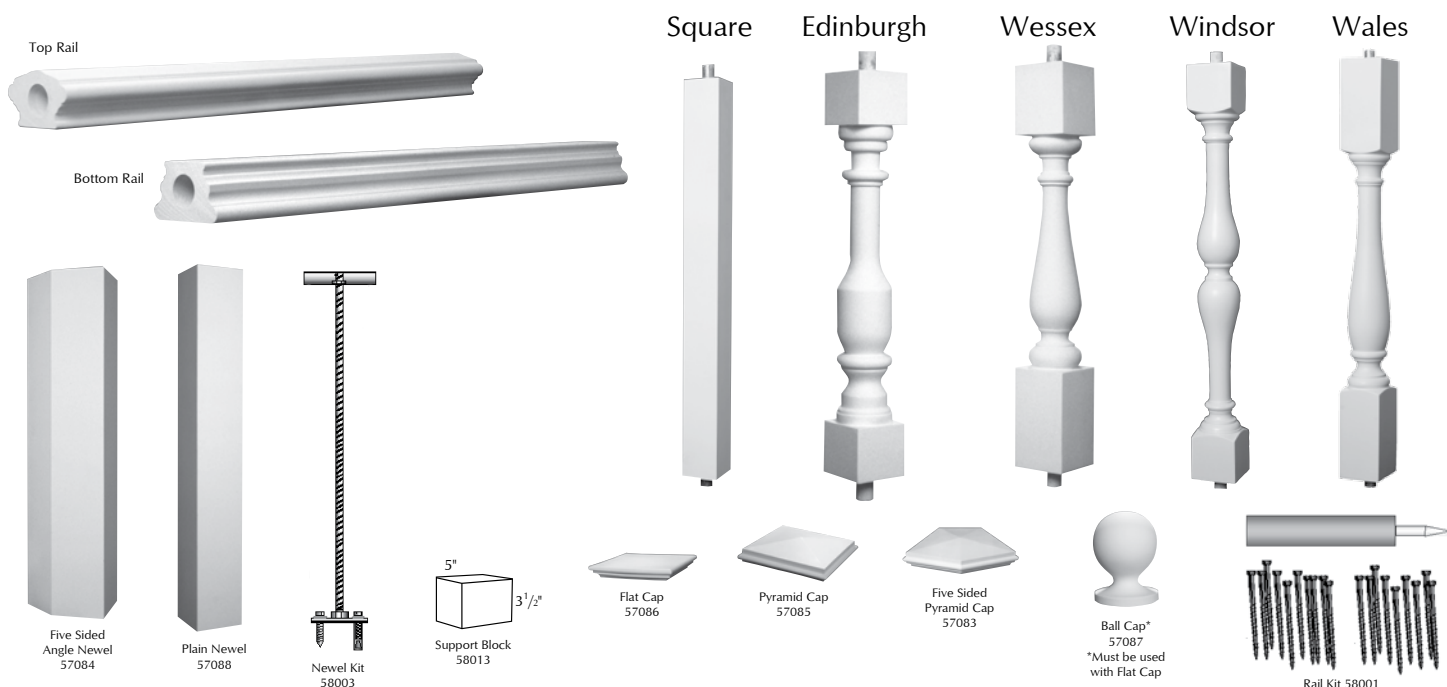

7" Balustrade System

Item	Length	Stock #	Carton Qty	Wt. (lbs.)	List Price Each	
Top Rail	8'	57031	1	36	\$421.99	
Top Rail	10'	57032	1	48	\$482.99	
Top Rail	12'	57033	1	55	\$544.99	
Bottom Rail	8'	57034	1	36	\$421.99	
Bottom Rail	10'	57035	1	48	\$482.99	
Bottom Rail	12'	57036	1	55	\$544.99	
Katharine	5-1/4" Baluster	5-1/4" x 23"	58041	1	7	\$118.99
	5-1/4" Baluster	5-1/4" x 29"	58045	1	7	\$186.99
	5-1/4" Extended Baluster	5-1/4" x 35"	58042	1	8	\$197.99
Caroline	5-1/4" Baluster	5-1/4" x 26"	58043	1	7	\$128.99
	5-1/4" Baluster	5-1/4" x 34"	58046	1	9	\$197.99
	5-1/4" Extended Baluster	5-1/4" x 40"	58044	1	9	\$205.99
Leslie Anne	5-1/4" Baluster	5-1/4" x 29"	58091	1	7	\$177.99
	5-1/4" Baluster	5-1/4" x 31"	58092	1	7	\$191.99
	5-1/4" Extended Baluster	5-1/4" x 36"	58093	1	9	\$199.99
Pyramid Cap	3"	57085	1	2	\$76.99	
Flat Cap	1-5/8"	57086	1	2	\$64.99	
Ball Top	8-1/4"	57087	1	2	\$102.99	
Five Sided Pyramid Cap	3"	57083	1	4	\$85.99	
Newel	48"	57088	1	29	\$285.99	
Five Sided Angel Newel	48"	57084	1	43	\$417.99	
Panel/Corner Newel	48"	57089	1	31	\$373.99	
Support Block	3"	58012	1	1	\$33.99	
Rail Kit	N/A	58001	1	1	\$36.99	
Newel Kit	N/A	58003	1	6	\$96.99	
Rail Kit for Five Sided Newel	N/A	58002	1	1	\$58.99	

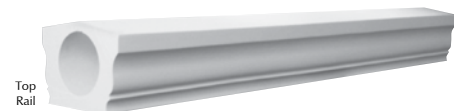

*Must be used
with Flat Cap

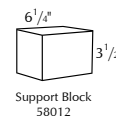

Katharine



Caroline



Leslie Anne

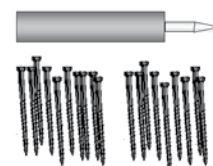

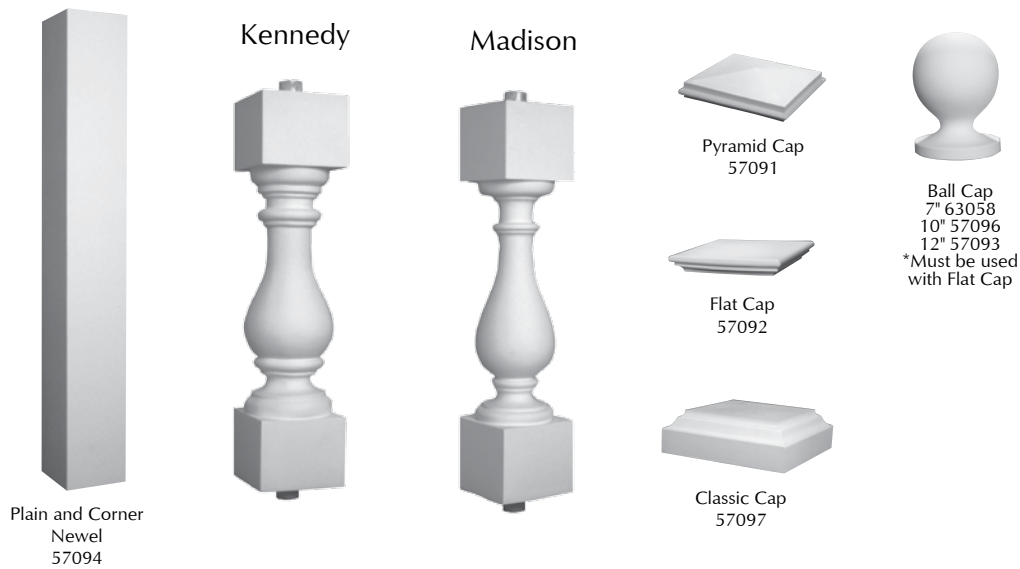

12" Balustrade System

Item	Length	Stock #	Carton Qty	Wt. (lbs.)	List Price Each	
Top Rail	8'	57061	1	56	\$614.99	
Top Rail	10'	57062	1	70	\$699.99	
Top Rail	12'	57063	1	84	\$752.99	
Bottom Rail	8'	57064	1	57	\$614.99	
Bottom Rail	10'	57065	1	71	\$699.99	
Bottom Rail	12'	57066	1	85	\$752.99	
Kennedy	7" Baluster	7" x 26"	58051	1	10	\$202.99
	7" Baluster	7" x 30"	58052	1	11	\$251.99
	7" Extended Baluster	7" x 38"	58053	1	16	\$269.99
Madison	7-1/4" Baluster	7-1/4" x 28"	58054	1	11	\$242.99
	7-1/4" Baluster	7-1/4" x 34"	58055	1	12	\$302.99
	7-1/4" Extended Baluster	7-1/4" x 40"	58056	1	16	\$311.99
Classic Cap	4-7/8"	57097	1	4	\$106.99	
Pyramid Cap	3"	57091	1	5	\$102.99	
Flat Cap	2"	57092	1	4	\$111.99	
Ball Top	7"	63058	1	2	\$181.99	
Ball Top	10"	57096	1	7	\$171.99	
Ball Top	12"	57093	1	10	\$216.99	
Newel	48"	57094	1	72	\$615.99	
Panel/Corner Newel	48"	57095	1	72	\$656.99	
Support Block	3-1/2"	58014	1	2	\$46.99	
Rail Kit	N/A	58001	1	1	\$36.99	
Newel Kit	N/A	58007	1	6	\$112.99	

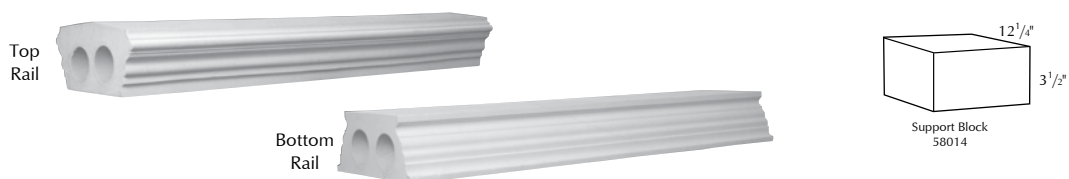

Curved Balustrade System Key Features:

- 6" and 7" Styles Available
- Low Maintenance
- Durable
- Decay Resistant
- Primed White (Ready to Paint)
- Easy to Install
- Available in 60"-108" radius in up to 10' lengths
- Modified and Custom Curved Rails Available
- 25 Year Limited Warranty



6" Curved Balustrade System

Stock #	Rail Length	Rail Radius	Description	List Price	Stock Number	Modified Radius	Modified List Price
58230	10'	60"	Top Rail	\$810.10	58230m	60"-66"	\$1,619.00
58232	10'	72"	Top Rail	\$810.10	58232m	67"-78"	\$1,619.00
58234	10'	84"	Top Rail	\$810.10	58234m	79"-90"	\$1,619.00
58236	10'	96"	Top Rail	\$810.10	58236m	91"-102"	\$1,619.00
58238	10'	108"	Top Rail	\$810.10	58238m	103" or greater	\$1,619.00
58240	10'	60"	Bottom Rail	\$810.10	58240m	60"-66"	\$1,619.00
58242	10'	72"	Bottom Rail	\$810.10	58242m	67"-78"	\$1,619.00
58244	10'	84"	Bottom Rail	\$810.10	58244m	79"-90"	\$1,619.00
58246	10'	96"	Bottom Rail	\$810.10	58246m	91"-102"	\$1,619.00
58248	10'	108"	Bottom Rail	\$810.10	58248m	103"- or greater	\$1,619.00

- Top and bottom rail only, must order balusters separately.

7" Curved Balustrade System

Stock #	Rail Length	Rail Radius	Description	List Price	Stock Number	Modified Radius	Modified List Price
58200	10'	60"	Top Rail	\$890.60	58200m	60"-66"	\$1,779.90
58202	10'	72"	Top Rail	\$890.60	58202m	67"-78"	\$1,779.90
58204	10'	84"	Top Rail	\$890.60	58204m	79"-90"	\$1,779.90
58206	10'	96"	Top Rail	\$890.60	58206m	91"-102"	\$1,779.90
58208	10'	108"	Top Rail	\$890.60	58208m	103" or greater	\$1,779.90
58210	10'	60"	Bottom Rail	\$890.60	58210m	60"-66"	\$1,779.90
58212	10'	72"	Bottom Rail	\$890.60	58212m	67"-78"	\$1,779.90
58214	10'	84"	Bottom Rail	\$890.60	58214m	79"-90"	\$1,779.90
58216	10'	96"	Bottom Rail	\$890.60	58216m	91"-102"	\$1,779.90
58218	10'	108"	Bottom Rail	\$890.60	58218m	103"- or greater	\$1,779.90

- Top and bottom rail only, must order balusters separately.

PVC Porch Ceiling					
Item	Width	Stock Number	Carton Qty	Weight (lbs)	List Price Each Piece
PVC Porch Ceiling - White	7-7/8" x 12'	56101	7	11.5	\$72.00
PVC Porch Ceiling - White	7-7/8" x 16'	56102	7	15.5	\$96.10
Ram Crown Moulding - White	2-1/16"	56106	1	1	\$54.90
Bed Moulding - White	1-1/4"	56107	1	1	\$24.40
Lattice Moulding - White	1-1/2"	56108	1	1	\$26.00

Pre-finished white. 7 pieces to a bundle.

Use it as low maintenance beaded ceiling or to accent any room as wainscoting.

One bundle covers: 12' - 55.3 sq.ft., 16' - 73.5 sq. ft; each piece covers: 12' - 7.9 sq.ft., 16' - 10.5 sq.ft.



Features

- Pre-finished white
- Can be painted using paint manufacturer's recommendations
- Hidden fastening (blind nail)
- Moulding is available in white only

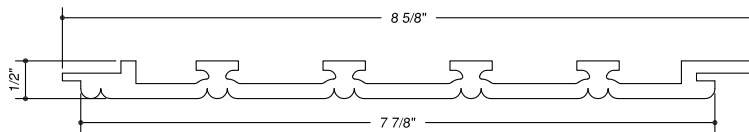

Ceiling Moulding



2-1/16" x 1-3/8" x 12'
56106



1-1/4" x 1-1/8" x 12'
56107

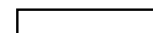

1-1/2" x 1/4" x 12'
56108

Item	Stock #	Dimensions*	List Price	Carton Qty.	Weight (lbs.)
Adams Bracket	70720	H - 17-1/4"; W - 2-3/4"; P - 13-1/4"	\$89.70	1	6
Bridgeport	70860	H - 15-1/4"; P - 15-1/4"	\$93.90	1	15
Chelsea Wood	70840	H - 13-3/8"; P - 13"	\$49.50	1	8
Chippendale	70770	H - 14-3/4"; P - 14-3/4"	\$53.80	1	11
Drury Lane	70890	H - 12-5/16"; P - 10-1/4"	\$48.20	1	11
Floral Bracket	70500	H - 13-1/4"; P - 10"	\$52.90	1	10
Hessian	70820	H - 15-7/8"; P - 15-7/8"	\$48.40	1	10
Lady Lucille	70710	H - 13-3/4"; W - 2-1/2"; P - 9-3/4"	\$102.80	1	6
Lions Gate	70740	H - 15"; P - 14"	\$65.40	1	13
Portsmouth	70810	H - 13-1/2"; P - 13-1/2"	\$64.40	1	10
Princess Anne	70610	H - 14-1/2"; W - 4"; P - 9-1/4"	\$96.10	1	10
Princess of Wales	70520	H - 19"; P - 15"	\$88.80	1	16
Roanoke House	70735	H - 16"; P - 9-1/4"	\$47.60	1	8
Saint Martin	70550	H - 14-1/16"; P - 12-1/16"	\$33.90	1	5
Seaside Bracket	70750	H - 11-13/16"; P - 11-13/16"	\$58.10	1	4
Sun Rays	70730	H - 12-1/4"; P - 12-1/4"	\$71.00	1	10
Smithson	70850	H - 15-3/8"; P - 15-3/4"	\$77.60	1	7
Townsend	70800	H - 9-1/8"; W - 3-1/2"; P - 6-7/8"	\$55.30	1	9
Trillium	70790	H - 22-7/8"; P - 13-1/4"	\$52.60	1	16
Victoria	70510	H - 15"; W - 4"; P - 9-1/2"	\$101.70	1	8
Belle Grande Centerpiece	70780	H - 5-15/16"; P - 24-1/4"	\$74.00	1	7
Fleur de lis Centerpiece	70725	H - 7-1/16"; L - 24"	\$71.30	1	8
Seaside Centerpiece	70760	H - 5-7/8"; L - 20-1/2"	\$52.40	1	4
Victoria Centerpiece	70870	H - 5-3/8"; W - 2"; L - 20"	\$47.60	1	5
Waverly Centerpiece	70880	H - 6"; L - 20"	\$47.10	1	4

*Bracket Dimensions

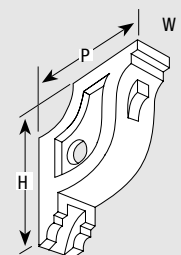

H - overall height of bracket
 W - width at widest point
 P - greatest point of projection

*Centerpiece Dimensions



H - overall height of centerpiece
 W - width at widest point
 L - overall length of centerpiece

Features

- 10 Year Warranty
- Weather, rot, and insect proof
- Manufactured from light-weight polyurethane

What You Need To Know

- Installs using common carpenter tools.
- Can be painted using paint manufacturer's recommendations. Dark colors not recommended.

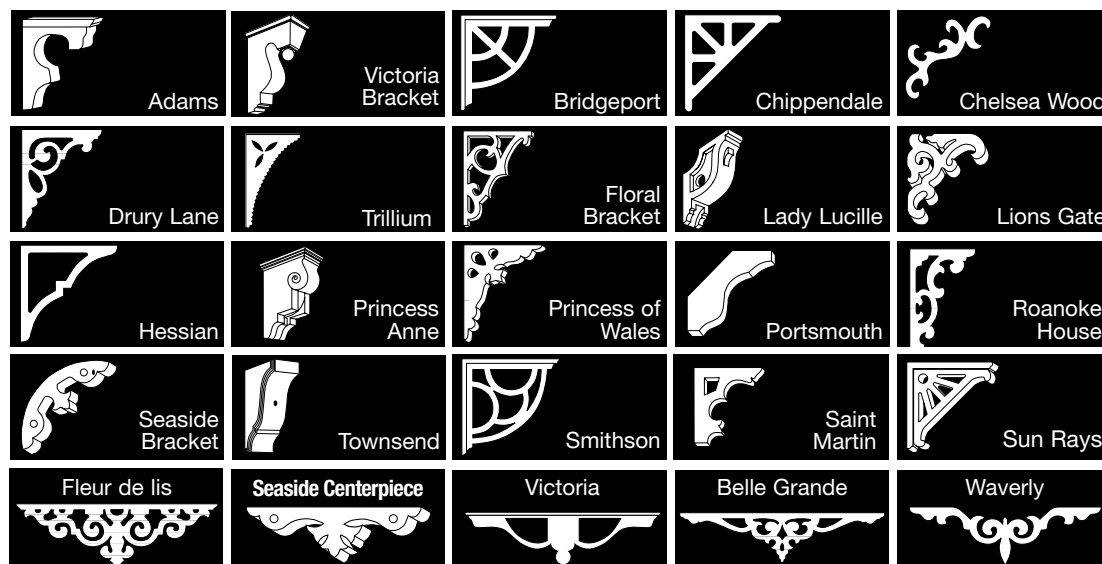

Medallions

Item	Diameter	Stock #	Carton Qty	Hole Diameter	List Weight (lbs)	Price Each
Ansley	16"	79481	1	4"	2	\$43.50
Ansley	23-3/8"	79482	1	4"	3	\$68.60
Ansley	29-1/2"	79483	1	4"	5	\$89.70
Ashton	17-1/2"	79170	1	1"	2	\$33.00
Belle Meade	12-1/4"	79120	1	1"	1	\$40.90
Biltmore	16-3/16"	79480	1	1"	2	\$54.10
Biltmore	25-3/4"	79479	1	1"	4	\$100.30
Bristol	16-1/8"	79470	1	4"	1	\$51.50
Bristol	23-5/8"	79471	1	4"	4	\$66.00
Bristol	29-3/4"	79472	1	4"	6	\$95.00
Cabot*	44-3/4"	79450	1	1"	13	\$213.80
Charlotte	24"	79478	1	1"	3	\$72.60
Cherub	22-3/16"	79469	1	4"	2	\$60.70
Cornwall	14-3/4"	79140	1	1"	1	\$31.70
Egg & Dart	18-1/2"	79485	1	4"	1	\$36.90
Egg & Dart	24"	79486	1	4"	5	\$67.30
Egg & Dart	30-5/8"	79487	1	4"	5	\$101.60
Florentine	29-1/8"	79465	1	1"	5	\$130.60
Lady Sarah	18"	79460	1	4"	2	\$42.20
Lady Sarah	23-5/8"	79461	1	4"	4	\$73.90
Montgomery	9-3/4"	79090	1	1"	1	\$29.00
Monticello	23-3/4"	79282	1	1"	4	\$85.80
Monticello	27-7/8"	79280	1	1"	7	\$110.80
Norwich	31-3/8"	79455	1	1"	5	\$80.50
Strasbourg**	27"	79475	1	N/A	4	\$208.50
Venetian	21-1/4"	79310	1	1"	2	\$68.20
Venetian	31"	79300	1	1"	7	\$133.30
Queen Anne	21"	79477	1	1"	2	\$59.40



Cabot



Florentine



Monticello



Norwich



Venetian



Cherub

* Cannot be shipped FedEx

** 2-5/8" recessed depth

Features

- Manufactured from light-weight polyurethane
- Virtually maintenance-free
- Primed white. Can be painted using paint manufacturer's recommendations
- 10 year warranty

Display Poster



Item # 16187
Size: 24" x 35"
List Price: \$8.00 each

Multi-Column Displays

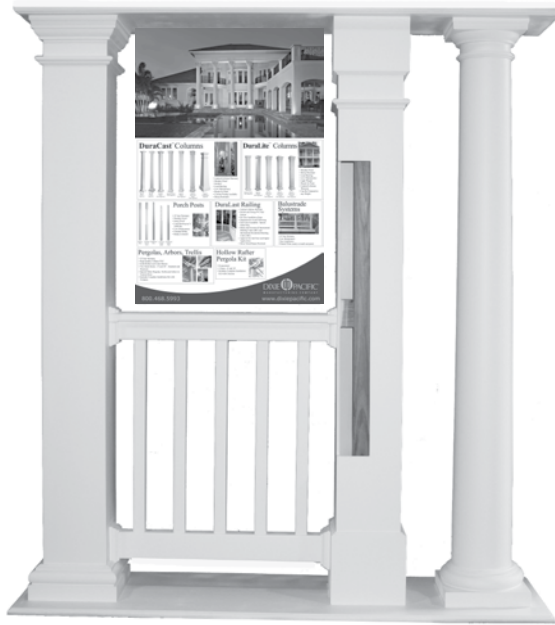

Item # 05002
Size: 48" x 18" x 72"
List Price: \$1,319.40
 (Shown) One Round and One Square DuraCast™ Column, One PVC Column, DuraLast Railing, Sign

Single Column Displays



Item # DSPLYSGLRFG
Size: 10"W x 81"H
List Price: \$240.00
 10" x 81" DuraCast™ Round Fiberglass Column (half plain/half fluted) with Tuscan Cap and Base/Plinth



Item # DSPLYSGLSFG
Size: 10"W x 81"H
List Price: \$240.00
 10" x 10" x 81" DuraLite® Square Plain Fiberglass Column with Tuscan Cap, Bead and Base/Plinth

Countertop Displays



Item # DSPLYRDFCT*
Size: 8"W x 24"H
List Price: \$120.00
 8" x 24" DuraCast™ Round Fiberglass Column (half plain/half fluted) with Tuscan Cap and Base/Plinth



Item # DSPLYSQFCT*
Size: 8"W x 24"H
List Price: \$120.00
 8" x 8" x 24" DuraLite® Square Plain Fiberglass Column with Tuscan Cap, Bead and Base/Plinth



Item # 05385
Size: 8"W x 18"H
List Price: \$95.00
 8" x 18" DuraCast™ Round Plain Fiberglass Column (1/2 Column Shaft)



Item # 05390
Size: 12" x 15"
List Price: \$66.00
 DuraLite® Recessed Sample



Item # 05388
Size: 12" x 15"
List Price: \$66.00
 DuraLite® Plain Sample



Item # 20075
Size: 12" x 15"
List Price: \$66.00
 DuraLast PVC Plain Sample

Terms and Conditions

Acceptance of Orders

All orders will be accepted subject to our ability to furnish all products and may be revoked after acceptance due to conditions beyond our control. Possession of the Dixie price list or catalog is not to be construed as an offer to sell the goods therein.

Order Entry

In order to help us better serve you, we ask that all orders be placed using both the description and the Dixie Stock Keeping Unit (SKU) number.

Order Changes and Cancellations

Changes or cancellations must be communicated in writing by facsimile, letter, or e-mail only. Cancellations of orders for stock merchandise that have been loaded and or shipped must be considered as returned merchandise. Once production has started, special orders can not be cancelled.

Payment Terms

Net invoice amount is due thirty (30) days from the invoice date.

Drop Shipments

The minimum net \$ drop shipment order that can be included in a Dixie pool truck is \$3,000.00 in shipping zone #1; \$3,500.00 in zone #2; and \$7,000.00 in zone #3, plus they will incur a Drop Charge of \$100.00. Note: Drop charges may be higher in some distant areas.

Job Site Deliveries

The minimum net \$ job site shipment that can be included in a Dixie pool truck is \$3,000.00 in shipping zone #1, \$3,500.00 in zone #2, and \$7,000.00 in zone #3, plus they will incur a job site delivery charge of \$250.00. A "Job Site Delivery Check List" must be completed prior to the loading of the truck. Note: Delivery charges may be higher in some distant areas.

Shipments and Claims

Our Dixie pool truck responsibility terminates upon delivery of goods to the buyer's designated place of delivery and receipt by us of a clear signed receipt that goods were examined and found to be in good condition.

Goods delivered by common carrier are F.O.B. Troy Alabama, and are the property of the consignee at the moment the truck leaves the dock. Freight charges will be prepaid and added to the invoice. The buyer must file any claims with the delivering carrier. A packaging, crating or palletizing charge of 10% of the net value of the product or a minimum charge of \$15.00 will be added to all products to help protect them. Dixie offers no guarantee that the product will arrive undamaged.

FedEx/Motor Freight

A handling charge of 10% of the net value of the product or a minimum of \$5.00 will be added.

Returned Merchandise Authorization (RMA)

- Only current made-to-stock items that are reported to be in saleable condition and purchased within the last 120 days will be accepted.
- All returned merchandise will be inspected and appropriate action will be taken to put the product into a saleable condition.
- Repair and repackaging charges will be deducted along with a minimum 35% restocking fee.
- All returns must be made within 30 days of the RMA date.
- Returned merchandise shipment must be prepaid. Collect shipments will be refused.

Order Minimums

The minimum net \$ order that can be included in a Dixie pool truck shipment to a distributor is:

Zone 1 \$3,000.00
Zone 2 \$3,500.00
Zone 3 \$7,000.00

HB&G and Dixie Pacific extend the following Limited Warranty (the “Warranty”) to “original purchasers” of its materials and components (the “Product”). An “Original Purchaser” is a retailer, distributor, builder, or supplier that purchases the Product or the first individual homeowner who purchases the Product from a retailer, distributor, builder, or supplier, whether or not the Product has been installed. This Warranty is not transferable to subsequent homeowners. HB&G and Dixie Pacific warrant that the Product, when properly installed, shall be free of manufacturing defects in workmanship and materials under conditions of normal use and service. If the Product fails to perform as warranted during the associated time periods listed below for each particular Product as a result of defective material or workmanship and meets the criteria laid forth in this Warranty, HB&G and Dixie Pacific will provide replacement parts of those materials that it deems defective after its review. Installation and labor costs are NOT covered under this Warranty. Non-factory-applied finishes are NOT covered under this Warranty. Original Purchasers must look to the warranty or warranties, if any, of the paint manufacturer associated with the paint applied to the Product for recourse as to defects or any other issue concerning applied finishes.

Limited Warranty Time Periods:

- PermaCast®, PermaLite®, DuraCast™, DuraLite® – Limited Lifetime
- Builders Select and Duralast Railing – Limited Lifetime
- Aluminum Columns – Limited Lifetime Component – 1 Year Color Fade
- Vinyl Post Wrap – Limited Lifetime
- PermaWrap® – 25 Year
- cPVC Pergola – 25 Year
- Fiberglass Pergola – Limited Lifetime
- PermaPost® – 25 Year
- Wrap N’ Snap Column Wrap® -25 Year
- PermaPorch® Railing – 25 Year Component – 10 Year Color Fade
- PermaPorch® Ceiling – 25 Year Component – 10 Year Color Fade
- Balustrade – 25 Year
- Brackets & Medallions – 10 Year
- Wood Columns – 1 Year
- Wood Turned Post – 1 Year

General Conditions & Exclusions:

This Warranty is not transferable and is subject to the following general conditions and exclusions:

Continued on next page

HB&G and Dixie Pacific Warranty Information

What is not covered:

There are certain conditions or applications over which HB&G and Dixie Pacific have no control. This Warranty does not cover defects or problems as a result of such conditions or applications, including but not limited to the following:

- Damage caused by improper installation, use, applications, or maintenance.
- Damage caused by environmental conditions or use that exceeds design standards.
- Damage caused by accidents, Acts of God, abuse, vandalism, animal activity, or any other external force.
- Damage resulting from mishandling in transit.
- Damages resulting from the failure to apply a finish to any purchased, unfinished Product.
- Damages caused by lack of routine maintenance, including but not limited to painting the product as needed.
- Modifications to the column, such as splitting the column, by anyone, including but not limited to a retailer, distributor, builder, or supplier.
- Normal weathering, chalking, fading, mildew buildup, or the effects of atmospheric pollutants.
- Non-Factory Applied finishes, applied sealants, or caulking.
- Installation or labor costs.
- Improper Installation, including but not limited to Installation in violation of building codes.
- Any product not manufactured by HB&G or Dixie Pacific.
- Damage or distortion to the Product caused by twisting, bowing, or other movement of the structure to which the Product is attached.
- Color matching of the Product material and any other HB&G or Dixie Pacific Material.

HB&G and Dixie Pacific make no other express warranties, oral, or written. By purchasing or using the Product, you agree that you are not relying on any oral statements made by anyone that are in any way contrary to this Warranty. HB&G and Dixie Pacific liability shall be limited in all instances to the remedy provided above; that is, the remedy stated above is your sole and exclusive remedy. HB&G and Dixie Pacific shall not be responsible for incidental or consequential damages relating to your purchase or use of the Product.

Statute of Limitations:

No action arising out of any claimed breach of this agreement by seller may be brought by buyer more than Ninety (90) Days after the cause of action has arisen.

Rights May Vary By State:

This warranty gives you specific legal rights and you may have other rights which vary from state to state. Some states do not allow the exclusions or limitations of incidental or consequential damages so the above limitations or exclusions may not apply to you.

This warranty is only applicable in the United States & Canada.

Visit www.dixiepacific.com for complete warranty.

