



## Accordion Doors / Zone 2

Woodfold Accordion Door Guide  
for Commercial and Residential Installations  
Detailed Architectural Shop Drawings Available

**Suggested List Prices / Freight Prepaid**  
All Continental States (except California, Oregon & Washington)

**Effective JAN. 1, 2014**

**Customer Service:** 503.357.7181  
**Email:** woodfold@woodfold.com

Standard and Optional Features	Series:	140	220	240	440	540	640	740	2100	3300
Continuous Pin-Hinge Hardware System, Top and Bottom		STD	STD	STD	STD	STD	STD	STD	STD	STD
Full-Length Sweptwing Handle with Magnet		STD	STD	—	—	—	—	—	—	—
Aluminum Lead Post		—	—	STD	STD	STD	STD	STD	STD	STD
Flexible Vinyl Panel Connector Inserted Directly into Panels		STD	STD	STD	—	—	—	—	STD	STD
Flexible Vinyl Panel Connector Inserted into Aluminum Side Channel		—	—	—	STD	—	—	—	—	—
Flexible Vinyl Panel Connector Inserted Solid Aluminum Panels		—	—	—	—	—	STD	—	—	—
Rigid Vinyl Panel Connector Inserted Into Aluminum Side Channel		—	—	—	—	STD	—	—	—	—
Rigid Vinyl Panel Connector Inserted Into Solid Aluminum Panels		—	—	—	—	—	—	STD	—	—
Nylon Wheel on Lexan Axle		STD	STD	—	—	—	—	—	—	—
Nylon Wheel with Ball Bearings on Steel Axle		OPT	OPT	STD	STD	STD	STD	STD	STD	STD
Aluminum Track		STD	STD	STD	STD	STD	STD	STD	STD	STD
Recessed Track Channel		OPT	OPT	OPT	OPT	OPT	OPT	OPT	—	OPT
Curvable Track		—	—	OPT	OPT	OPT	OPT	OPT	—	—
Magnetic Catch and Strike Plate		STD	STD	OPT	OPT	OPT	OPT	OPT	OPT	OPT
Deadlatch with Thumb Turn Two Sides		—	—	STD	STD	OPT	STD	OPT	STD	STD
Keylock Two Side		—	—	OPT	OPT	STD	OPT	STD	OPT	OPT
May Be Paired		—	—	OPT	OPT	OPT	OPT	OPT	OPT	OPT
Sliding Jamb Option		—	—	OPT	OPT	OPT	OPT	OPT	OPT	OPT
Class 1 Fire Retardant Panels (Light Oak and Chalk Vinyl-Lam Only)		—	OPT	OPT	OPT	OPT	—	—	OPT	OPT

### Measuring Width and Height

**List finished opening sizes.** (A) Width: Finished wall-to-wall (or jamb) in feet and inches, e.g. 10'-5" x 7'-10"; (B) Height: From surface where track attaches to finished floor or top of carpet. **See Page 4—drawings show how to measure height for each type of track.**

NOTE: For those areas where the floor is uneven (e.g. concrete floors) please take 3 or 4 height measurements along the floor. Use the shortest measurement as the finished opening height except 2100 or 3300.

**Woodfold  
order  
forms  
available**

**Prepaid Freight Program** All prices shown in this price list include freight for Zone 2—all continental states except California, Oregon & Washington.

**Production Schedule:** All Series with factory standard finishes, 2 weeks (up to 250 lineal feet; over 250 lineal feet, subject to manufacturers schedule at time of order). All doors with special finish, after signed approval acknowledgment received, 3 weeks.

**Rush service:** Please contact office for details.

**In-transit time:** Please allow a 7 to 10 day normal in-transit time for delivery.

Door weights (lbs. per lineal foot):	Height	Series 140, 220, 240, 2100	Series 440, 540, 640, 740	Series 3300
	6-8	10	—	—
8-0	12	13	26	
10-0	15	16	32	
12-0	18	N/A	38	

**Shipments to non-commercial addresses:** Additional charges apply for non-commercial delivery and pre-delivery notification. Contact office for questions.

**Special note:** In case of freight damage documented with signed bill of lading, please contact our office. Woodfold will process freight claim.

## Custom sizes are our specialty

### Custom Order Information

All Woodfold doors are custom made. We allow 9/16" clearance for doors over 4' high, 5/16" for doors 4' and less. Beware of variations in floor and/or ceiling surfaces of more than 3/4". Please contact us for more information.

**Special finishes procedure:** With your order please send stained wood sample or paint chip to be matched by Woodfold. Upon receiving this sample we will return a factory color-matched sample along with an acknowledgment copy. Acknowledgment is to be returned with your signature approving the color match. By using the special finish procedure to color match to your customer requirements, the special finish cost will be less than preparing an unfinished door for finishing at the job site.

### Unfinished doors are not guaranteed

Series 3300 is not available unfinished

**Woodfold finishing processes are environmentally safe**

# Residential Series 140

## Closet Folding Doors—Faced One Side Only

- Order must specify left- or right-hand stack.
- Not available as pairs
- When pairs are required, use Series 240.

**Freight Prepaid** 

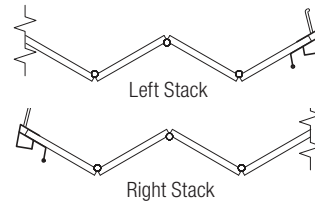

### The Accordion Door That:

- Is FULLY Guaranteed
- STACKS in Minimum Space
- STAYS PUT in Open and Closed Position
- Has Exclusive Pin-Hinge Hardware Top and Bottom for Added Strength

### Series 140 Specifications

**Panels:** 4'-1/4" wide.

**Factory finished hardwoods:**

For visual warmth, hardwood veneers laminated to MDF board (1/4" net) with non-tinted finish. Good one side.

**Vinyl-Lam:** Wood grains, white, tan, gray, or 2-tone textured vinyl laminated to MDF board (1/4" net), faced one side only.

**Catch:** Magnet with strike plate.

**Widths:** Up to 8'. (note: For closet enclosures more than 8' wide, use Series 240 with closet-back option, page 5).

**Heights:** Up to 8'-1".

**Wheels:** Nylon wheels on Lexan axles.

**Vinyl panel connectors:**

Supplied as standard—

**White** with White, Chalk, and Amethyst.

**Sand** with Hardwoods: Oak, Birch, Maple; and Vinyls: Natural Oak, Birch, Tan, Tahiti, Rattan, Maple, Alder.

**Gray** with Gray Vinyl.

**Brown** with all other body panels.

**Stacking space:** 1-1/4" per foot plus 7/8" for sweptwing handle.

**Note: Not available with curved track.**



### List Price Schedule (Price to next full foot width and height)

Use for Custom and Stock Sizes		Series 140V Vinyl-Lam	Series 140H Natural Hardwoods			
Finished Openings up to		Cherry, Maple, Gray, Birch, Natural Oak, Light Oak, Dark Oak, Teak, Mahogany, Walnut, White, Tan, Chalk, Tahiti, Rattan, Amethyst	Factory Finished			
Width x Height	Birch		Oak	Cherry Walnut	Alder Mahogany Maple	
Heights up to 6'-10" No Extra Charge	2-0 x 6-8	230	398	404	520	464
	3-0 x 6-8	345	597	606	780	696
	4-0 x 6-8	460	796	808	1040	928
	5-0 x 6-8	575	995	1010	1300	1160
	6-0 x 6-8	690	1194	1212	1560	1392
	7-0 x 6-8	805	1393	1414	1820	1624
Heights up to 8'-1" No Extra Charge	8-0 x 6-8	920	1592	1616	2080	1856
	2-0 x 8-0	258	444	450	572	514
	3-0 x 8-0	387	666	675	858	771
	4-0 x 8-0	516	888	900	1144	1028
	5-0 x 8-0	645	1110	1125	1430	1285
	6-0 x 8-0	774	1332	1350	1716	1542
7-0 x 8-0	903	1554	1575	2002	1799	
8-0 x 8-0	1032	1776	1800	2288	2056	

Maximum size for Series 140: 8-0 x 8-1

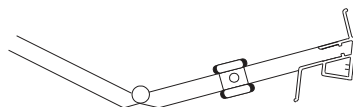

Series 140 with full-length sweptwing handle with integral magnet and steel hardware hinge (top view). Note: The first body panel acts as lead panel.

### Series 140 Options

- **Custom-size doors .... no additional charge**  
*Use price for next larger width and height shown; see Page 1 for providing custom-size details.*
- **Heights 4' and less** ..... less 20%  
*Use 8-0 height price.*
- **Double end** ..... \$20  
*Single door with sweptwing handle both ends.*
- **Not available with keylocks or privacy latches (for these options, use Series 240 with closet back).**
- **Special paint and stain** ..... \$40 lin. ft.  
*\$100 minimum. Note: For custom paint finish, use wood grain vinyl price base (MDF board with paper overlay used for paint finish). For stain finish, use wood-species base price. See front cover for details.*
- **Fire-retardancy** ..... N/A  
*Panels with fire-retardant core not available in Series 140. Please refer to options for Series 220 and 240.*

# Residential Series 220

## Room Dividers and Passageway Doors

- Not available as pairs.
- When pairs are required, use Series 240.
- Built left-hand stack unless otherwise specified.

Freight Prepaid 

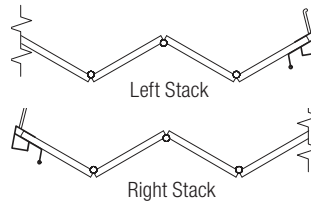

### How To Order (Custom Sizes Our Specialty)

- 1) WIDTH: Finished wall-to-wall (or jamb) in feet and inches.
- 2) HEIGHT: Surface where track attaches to finished floor or top of carpet in feet and inches.
- 3) SERIES: List number of series to be ordered.
- 4) PANEL: List wood species or vinyl-lam color.
- 5) OPTIONS: List options if required.

### Series 220 Specifications

**Panels:** 4-1/4" wide.

**Factory finished hardwoods:**

For visual warmth, hardwood veneers laminated to MDF board (1/4" net) with non-tinted finish.

**Vinyl-Lam:** Wood grains, white, tan, gray, or 2-tone textured vinyl laminated to MDF board (1/4" net).

**Catch:** Magnet with strike plate

**Widths:** Up to 8'. (Note: For room dividers more than 8' wide, use Series 240, Page 5).

**Heights:** Up to 8'-1".

**Wheels:** Nylon wheels on Lexan axles.

**Vinyl panel connectors:**

Supplied as standard—

**White** with White, Chalk, and Amethyst.

**Sand** with Hardwoods: Oak, Birch, Maple; and Vinyls: Natural Oak, Birch, Tan, Tahiti, Rattan, Maple, Alder.

**Gray** with Gray Vinyl.

**Brown** with all other body panels.

**Stacking space:** 1-1/4" per foot plus 7/8" for sweptwing handle.

**Note: Not available with curved track.**



### List Price Schedule (Price to next full foot width and height)

Use for Custom and Stock Sizes	Series 220V Vinyl-Lam	Series 220H Natural Hardwoods				
		Factory Finished				
Finished Openings up to	Cherry, Maple, Gray, Birch, Natural Oak, Light Oak, Dark Oak, Teak, Mahogany, Walnut, White, Tan, Chalk, Tahiti, Rattan, Amethyst					
		Birch	Oak	Cherry Walnut	Alder Mahogany Maple	
Heights up to 6'-10" No Extra Charge	2-0 x 6-8	240	406	412	532	476
	3-0 x 6-8	360	609	618	798	714
	4-0 x 6-8	480	812	824	1064	952
	5-0 x 6-8	600	1015	1030	1330	1190
	6-0 x 6-8	720	1218	1236	1596	1428
	7-0 x 6-8	840	1421	1442	1862	1666
	8-0 x 6-8	960	1624	1648	2128	1904
Heights up to 8'-1" No Extra Charge	2-0 x 8-0	268	452	458	586	524
	3-0 x 8-0	402	678	687	879	786
	4-0 x 8-0	536	904	916	1172	1048
	5-0 x 8-0	670	1130	1145	1465	1310
	6-0 x 8-0	804	1356	1374	1758	1572
	7-0 x 8-0	938	1582	1603	2051	1834
	8-0 x 8-0	1072	1808	1832	2344	2096

Maximum size for Series 220: 8-0 x 8-1

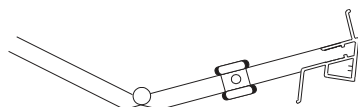

Series 220 with full-length sweptwing handle with integral magnet and steel hardware hinge (top view). Note: The first body panel acts as lead panel.

### Series 220 Options

- **Custom-size doors .... no additional charge**  
*Use price for next larger width and height shown; see Page 1 for providing custom-size details.*
- **Heights 4' and less** ..... less 20%  
*Use 8-0 height price.*
- **Double end** ..... \$20  
*Single door with sweptwing handle both ends.*
- **Not available with keylocks or privacy latches (for these options, use Series 240).**
- **Special paint and stain** ..... \$40 lin. ft.  
*\$100 minimum. Note: For custom paint finish, use wood grain vinyl price base (MDF board with paper overlay used for paint finish). For stain finish, use wood-species base price. See front cover for details.*
- **Fire-retardancy** ..... add 40%  
*Panels with Class 1 fire-retardant core. Available in light oak and chalk vinyl-lam only.*

# Construction Details Series 240, 440, 540, 640, 740

## Standard Surface Track

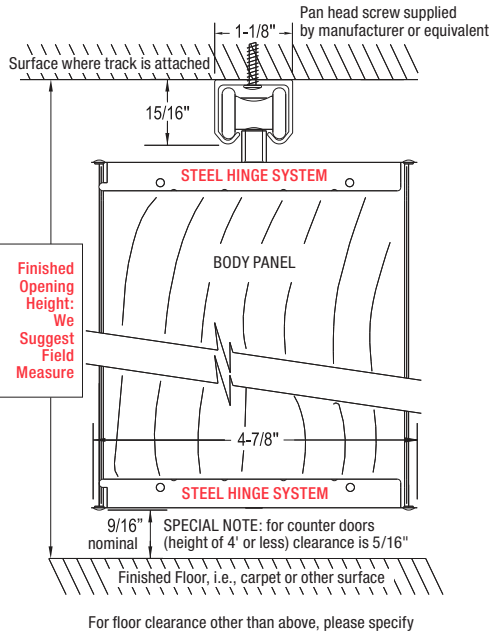

## Stack Dimensions

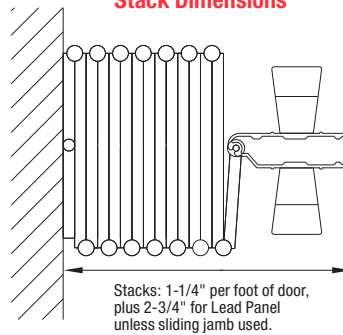

## Lead Post

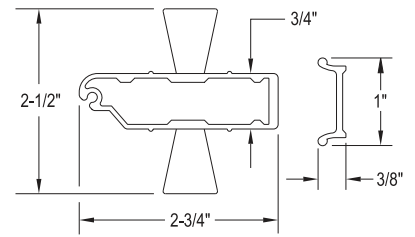

## Mounting Panel

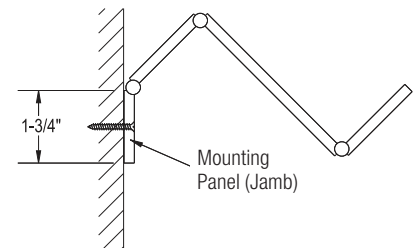

## Door Types

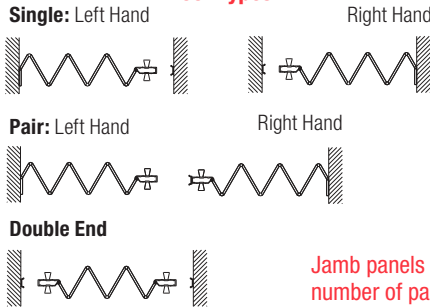

Jamb panels may orient into or out of room based on number of panels in door. Applies to all series except 3300.

# Option Details Series 240, 440, 540, 640, 740

## Woodfold Customer Service:

503.357.7181 / woodfold@woodfold.com

## Locking Hardware

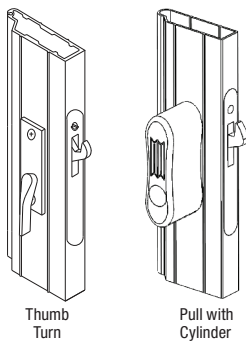

- **Deadlatch**  
Deadlatch with thumb turn two sides
  - **Keylock 1 Side**  
Deadlatch with thumb turn one side, keylock one side
  - **Keylock 2 Sides**  
Deadlatch with keylock 2 sides
- Custom Keying Information**  
Woodfold furnishes Weiser, Schlage, and a construction best cylinder.

## Intermediate Rolling Post

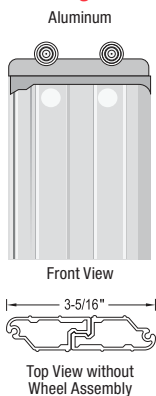

Each half of the post applied to section of Room Divider at plant. Fastening of sections at job site with screws and posts supplied.

## Recessed Track

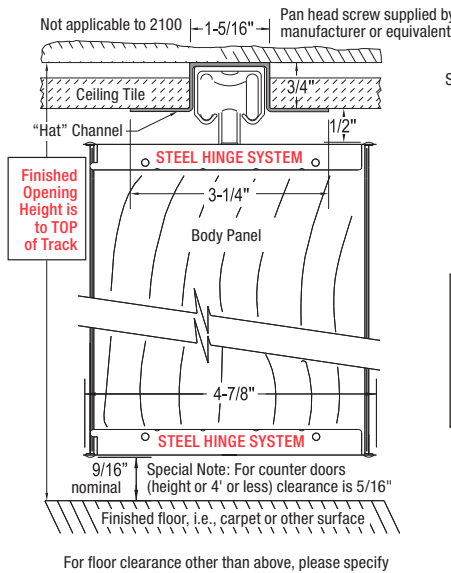

## Curvable Track

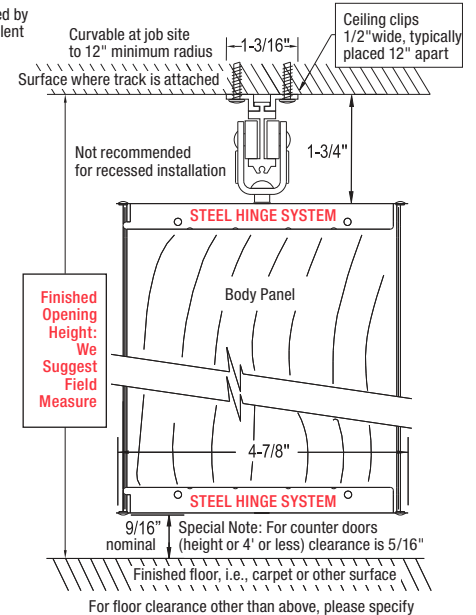

## Sliding Jamb Option

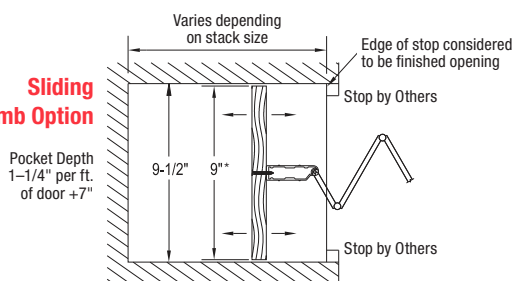

\* May be cut to a minimum of 6-1/2" in the field

## Multiple Meeting Post

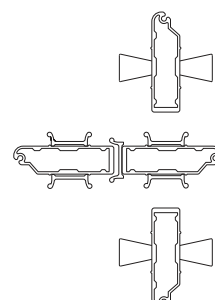

Up to four way use of jamb mold in place of handle on sides of lead panel

Primary lead post with auxiliary jamb moldings

# Commercial Series 240

Room Dividers and Passageway Doors

Freight  
Prepaid 

### Series 240 Specifications

**Panels:** 4-1/4" wide.

#### Factory finished hardwoods:

For visual warmth, hardwood veneers laminated to MDF board (1/4" net) with non-tinted finish.

**Vinyl-Lam:** Wood grains, white, tan, gray, or 2-tone textured vinyl laminated to MDF board (1/4" net).

**Lead Post:** 3/4" x 2-3/4" aluminum with ball-bearing rollers.

**Latch:** Deadlatch with thumb turn two sides.

**Widths:** No limitation.

**Heights:** Up to 12'-1" on vinyl and 10'-1" on hardwood.

#### Vinyl panel connectors:

Supplied as standard—

**White** with White, Chalk, and Amethyst.

**Sand** with Hardwoods: Oak, Birch, Maple; and Vinyls: Natural Oak, Birch, Tan, Tahiti, Rattan, Maple, Alder.

**Gray** with Gray Vinyl.

**Brown** with all other body panels.

**Wheels:** Ball-bearing nylon wheels on steel axles.

**Stacking space:** 1-1/4" per foot plus 2-3/4" for lead post.

### How To Order (Custom Sizes Our Specialty)

- 1) WIDTH: Finished wall-to-wall (or jamb) in feet and inches.
- 2) HEIGHT: Surface where track attaches to finished floor or top of carpet in feet and inches.
- 3) SERIES: List number of series to be ordered.
- 4) PANEL: List wood species or vinyl-lam color.
- 5) OPTIONS: List options if required.

### Series 240 Options

- **Custom-sizes** ..... no additional charge
- **Heights 4' and less** ..... less 20%  
*Use 8-0 height price.*
- **Made as pairs** ..... \$40
- **Double end lead post** ..... \$40
- **Intermediate rolling post** ..... \$60  
*For sectioning extra-wide dividers and to provide a surface to attach foot-bolt. See Page 4.*
- **Closet backs on Series 240** ..... Less 10%  
*Order right or left hand. Available up to 8'1" height.*
- **Unfinished doors**  
*Not guaranteed. Use finished door prices.*
- **Special paint and stain** ..... \$40 lin. ft.  
*\$100 minimum. Note: For custom paint finish, use wood grain vinyl price base (MDF board with paper overlay used for paint finish). For stain finish, use wood-species base price. See front cover for details.*
- **Custom decorative laminate doors**  
*Contact office for quotation.*
- **Magnet with strike plate** ..... N/C
- **Thumb turn two sides** ..... STD  
*Deadlatch with thumb turn two sides.*
- **Thumb turn one side** ..... N/C  
*Deadlatch with thumb turn one side.*
- **Keylock 1 side (Weiser or Schlage cylinder)** ... \$30
- **Keylock 1 side (Best cylinder pull w core)** .... \$120  
*Deadlatch with thumb turn one side.*
- **Keylock 2 sides (Weiser or Schlage cylinder)** \$60
- **Keylock 2 sides (Best cylinder pull w core)** .... \$240  
*Deadlatch with keylock two sides.*
- **Non-locking foot-bolt** ..... \$36
- **Foot-bolt with spring pull** ..... \$72
- **Locking foot-bolts** ..... \$76
- **Double locking foot-bolts** ..... \$152
- **Recessed hat channel** ..... \$8 lin. ft.  
*Measure to top of track.*
- **Curvable "I" beam track** ..... \$16 lin. ft.
- **Sliding jamb panel** ..... \$60
- **Fire-retardancy** ..... add 40%  
*Panels with Class 1 fire-retardant core. Available in light oak and chalk vinyl-lam only (closet back not available with firecore).*

### List Price Schedule (Price to next full foot width and height)

Use for Custom and Stock Sizes		Series 240V Vinyl-Lam	Series 240H Natural Hardwoods			
Finished Openings up to		Cherry, Maple, Gray, Birch, Natural Oak, Light Oak, Dark Oak, Teak, Mahogany, Walnut, White, Tan, Chalk, Tahiti, Rattan, Amethyst	Factory Finished			
Width x Height			Birch	Oak	Cherry Walnut	Alder Mahogany Maple
Heights up to 6'10" No Extra Charge	2-0 x 6-8	292	476	482	612	550
	3-0 x 6-8	438	714	723	918	825
	4-0 x 6-8	584	952	964	1224	1100
	5-0 x 6-8	730	1190	1205	1530	1375
	6-0 x 6-8	876	1428	1446	1836	1650
	7-0 x 6-8	1022	1666	1687	2142	1925
	8-0 x 6-8	1168	1904	1928	2448	2200
	9-0 x 6-8	1314	2142	2169	2754	2475
	10-0 x 6-8	1460	2380	2410	3060	2750
	Use liner foot price list for all other widths		146 lin. ft.	238 lin. ft.	241 lin. ft.	306 lin. ft.
Heights up to 8'1" No Extra Charge	5-0 x 8-0	880	1335	1355	1700	1535
	6-0 x 8-0	1056	1602	1626	2040	1842
	7-0 x 8-0	1232	1869	1897	2380	2149
	8-0 x 8-0	1408	2136	2168	2720	2456
	9-0 x 8-0	1584	2403	2439	3060	2763
	10-0 x 8-0	1760	2670	2710	3400	3070
	11-0 x 8-0	1936	2937	2981	3740	3377
	12-0 x 8-0	2112	3204	3252	4080	3684
	13-0 x 8-0	2288	3471	3523	4420	3991
	Use liner foot price list for all other widths		176 lin. ft.	267 lin. ft.	271 lin. ft.	340 lin. ft.
Heights up to 10'1" No Extra Charge	10-0 x 10-0	2170	3430	3400	4410	4130
	11-0 x 10-0	2387	3773	3740	4851	4543
	12-0 x 10-0	2604	4116	4080	5292	4956
	13-0 x 10-0	2821	4459	4420	5733	5369
	14-0 x 10-0	3038	4802	4760	6174	5782
	15-0 x 10-0	3255	5145	5100	6615	6195
Use liner foot price list for all other widths		217 lin. ft.	343 lin. ft.	340 lin. ft.	441 lin. ft.	413 lin. ft.
Heights up to 12'1" No Extra Charge	12-0 x 12-0	3408	<b>Note: Hardwoods not available in heights over 10'-1"</b>			
	13-0 x 12-0	3692				
	14-0 x 12-0	3976				
	15-0 x 12-0	4260				
	Use liner foot price list for all other widths					

# Visifold Series 440/540

Acrylic Panel Dividers



## Series 440/540 Specifications

### Aluminum panel frame channels:

Clear finish*	440C	540C
White finish*	440W	540W
Bronze finish**	440B	540B
Sand finish**	440S	540S

\* Supplied with clear hinging and track.  
 \*\* Supplied with bronze hinging and track.

**Panels:** 4-1/4" wide.

### Acrylic panels:

1/8" thick transparent clear or bronze.

### Panel connectors:

Series 440—Extruded flexible vinyl.  
 Series 540—Rigid vinyl hinge profile over steel rod.

### Wheels:

Ball-bearing nylon wheels on steel axles.

### Latch:

Series 440—Deadlatch with thumb turn two sides.  
 Series 540—Deadlatch with keylock turn two sides.

**Widths:** No limitations.

**Heights:** Up to 10'-1".

**Stacking space:** 1-1/4" per foot plus 2-3/4" for lead post.

## List Price Schedule (Prices per lineal foot to the next full foot)

Clear Acrylic Panels - Bronze Acrylic Panels - Vinyl-Lam Panels

	Series 440	Series 540	Hardwoods by quote
To 8'-1" height	299	354	
To 10'-1" height	408	497	

Prices shown are per lineal foot

# Alumifold Series 640/740

Aluminum Panel Dividers



## Series 640/740 Specifications

**Panels construction:** 4-1/4" wide aluminum panels available in solid or perforated style. Frame channel is integral part of panel.

### Panel connectors:

Series 640—Extruded flexible vinyl.  
 Series 740—Rigid vinyl hinge profile over steel rod.

### Wheels:

Ball-bearing nylon wheels on steel axles.

### Latch:

Series 640—Deadlatch with thumb turn two sides.  
 Series 740—Deadlatch with keylock turn two sides.

**Widths:** No limitations.

**Heights:** Up to 10'-1".

**Stacking space:** 1-1/4" per foot plus 2-3/4" for lead post.

## List Price Schedule (Prices per lineal foot to the next full foot)

	Series 640 Solid / Perforated	Series 740 Solid / Perforated
Clear, Bronze, or Gold* to 8'-1" height	308 / 361	358 / 412
Clear only to 10'-1" height	403 / 487	465 / 552

\*Add 20% for gold. Prices shown are per lineal foot.

## Combination doors:

Series 240 may be combined with either Series 440 or 640. To price combinations, use the applicable price list for each portion of the door. A diagram must be supplied noting location of each series.

## Gold finish option:

Series 440 and 540 may be ordered with steel hinge hardware, aluminum components, and vinyl extrusions finished in a gold color. Add 20%.

## Series 440/640 Options

Use Series 240 Option Prices on Page 5

## Series 540/740 Options

- **Heights 4' and less** ..... less 20%  
*Use 8-0 height price.*
- **Made as pairs** ..... \$40
- **Double-end lead post** ..... \$110  
*Includes keylock 2 sides.*
- **Intermediate rolling post** ..... \$60  
*For sectioning extra-wide store enclosures and/or providing a surface for attaching security bolt.*
- **Keylock 2 sides** (Weiser or Schlage cylinder) . STD
- **Keylock 2 sides** (Best cylinder pull w core) ... \$180  
*Deadlatch with keylock two sides.*
- **Pull rod** ..... \$30
- **Locking foot bolts** ..... \$76
- **Double locking foot-bolts**  
*(floor to ceiling)* ..... \$152
- **Non-locking foot-bolt** ..... \$36
- **Foot-bolt with spring pin** ..... \$72
- **Locking dust-proof strike** ..... \$36  
*Normally inserted in floor to receive security bolt,*
- **Curvable "I" beam track** ..... \$16 lin. ft.
- **Sliding jamb panel** ..... \$100

# Sound Rated Series 2100

Acoustical Rating of FSTC 21

Field Sound Transmission Class (FSTC): 21

Test performed by Bruck, Richards & Chaudiere, Inc. ASTM designation E336-77

Freight Prepaid



## Series 2100 Specifications

**Panels:** 4-1/4" wide.

**Factory finished hardwoods:** For visual warmth, hardwood veneers laminated to MDF board (1/4" net) with non-tinted finish.

**Vinyl-Lam:** wood grains, white, tan, gray, or 2-toned textured vinyl laminated to MDF board (1/4" net).

**Stacking space:** 1-1/4" per foot plus 2-3/4" for lead post.

**Molding:** Supplied as standard.

**Widths:** No limitation.

**Heights:** Up 12'-1" on vinyl and 10'-1" on hardwood.

**Vinyl panel connectors:**

Supplied as standard—

**White** with White, Chalk, and Amethyst.

**Sand** with Hardwoods: Oak, Birch, Maple; and Vinyls: Natural Oak, Birch, Tan, Tahiti, Rattan, Maple, Alder.

**Gray** with Gray Vinyl.

**Brown** with all other body panels.

**Wheels:** Ball-bearing nylon wheels on steel axles.

**Latch:** Deadlatch with thumb turn two sides.

**Note: Not available with curved track or recessed track channel.**

## List Price Schedule (Prices per lineal foot to the next full foot)

Use for Custom and Stock Sizes		Series 2100V Vinyl-Lam	Series 2100H Natural Hardwoods			
Finished Openings up to		Cherry, Maple, Gray, Birch, Natural Oak, Light Oak, Dark Oak, Teak, Mahogany, Walnut, White, Tan, Chalk, Tahiti, Rattan, Amethyst	Factory Finished			
Height			Birch	Oak	Cherry Walnut	Alder Mahogany Maple
Prices shown are per lineal foot	8'-1"	232	342	345	415	382
	10'-1"	274	423	420	524	495
	12'-1"	362	Hardwoods not available in heights over 10'1"			

# Sound Rated Series 3300

Acoustical Rating of FSTC 33

Field Sound Transmission Class (FSTC): 33

Test performed by Bruck, Richards & Chaudiere, Inc. ASTM designation E336-90

## Series 3300 Specifications

**Factory finished hardwoods:**

For visual warmth, hardwood veneers laminated to MDF board (1/4" net) with non-tinted finish.

**Vinyl-Lam:** wood grains, white, tan, gray, or 2-toned textured vinyl laminated to MDF board (1/4" net).

**Widths:** Individual section max. 15'; use intermediate post for wider openings.

**Heights:** Up 12'-1" on vinyl and 10'-1" on hardwood.

**Latch:** Deadlatch with thumb turn two sides.

**Wheels:**

1-1/8" ball-bearing nylon wheels on steel axles.

**Vinyl panel connectors:** Supplied as standard—

**White** with White, Chalk, and Amethyst.

**Sand** with Hardwoods: Oak, Birch, Maple; and Vinyls: Natural Oak, Birch, Tan, Tahiti, Rattan, Maple, Alder.

**Gray** with Gray Vinyl.

**Brown** with all other body panels.

**Track:** Clear aluminum with white wood moulding.

**Stacking space:** 2" per foot plus 4-1/2" for lead post, 12-1/4" side to side.

**Note: Series 3300 not available unfinished or with curved track.**

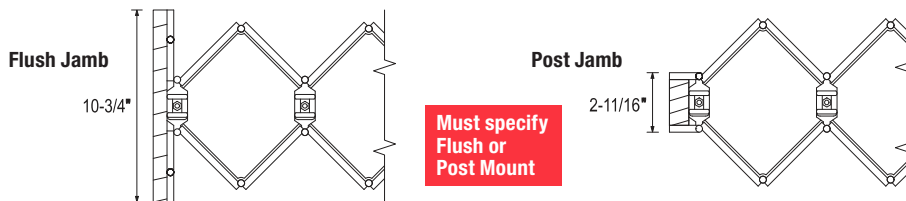

## List Price Schedule (Prices per lineal foot to the next full foot)

Use for Custom and Stock Sizes		Series 3300V Vinyl-Lam	Series 3300H Natural Hardwoods			
Finished Openings up to		Cherry, Maple, Gray, Birch, Natural Oak, Light Oak, Dark Oak, Teak, Mahogany, Walnut, White, Tan, Chalk, Tahiti, Rattan, Amethyst	Factory Finished			
Height			Birch	Oak	Cherry Walnut	Alder Mahogany Maple
Prices shown are per lineal foot	8'-1"	549	766	723	905	840
	10'-1"	641	926	910	1007	1044
	12'-1"	726	Hardwoods not available in heights over 10'1"			

## Series 2100 Options

- **Custom-sizes** ..... no additional charge
- **Heights 4' and less** ..... less 20%  
*Use 8-0 height price.*
- **Made as pairs** ..... \$40
- **Special paint and stain** ..... \$40 lin. ft.  
*\$100 minimum. Note: For custom paint finish, use wood-grain vinyl price base (MDF board with paper overlay used for paint finish). For stain finish, use wood-species base price. See front cover for details.*
- **Custom decorative laminate doors**  
*Contact office for quotation.*
- **Keylock 1 side** (Weiser or Schlage cylinder) ..... \$30
- **Keylock 1 side** (Best cylinder pull w core) ..... \$120  
*Deadlatch with thumb turn one side, keylock one side.*
- **Keylock 2 sides** (Weiser or Schlage cylinder) ..... \$60
- **Keylock 2 sides** (Best cylinder pull w core) ..... \$240  
*Deadlatch with keylock two sides.*
- **Non-locking foot-bolt** ..... \$36
- **Double end lead post** ..... \$72
- **Pull rod** ..... \$30
- **Intermediate rolling post** (metal) ..... \$60  
*For sectioning extra-wide room dividers, and/or to provide a surface for attaching foot-bolt. See detail Page 4.*
- **Sliding jamb panel** ..... \$100
- **Fire-retardancy** ..... add 40%  
*Panels with Class 1 fire-retardant core. Available in light oak and chalk vinyl-lam only.*

## Series 3300 Options

- **Custom-sizes** ..... no additional charge
- **Made as pairs** ..... \$100
- **Special paint and stain** ..... \$60 lin. ft.  
*\$100 minimum. Note: For custom paint finish, use wood-grain vinyl price base (MDF board with paper overlay used for paint finish). For stain finish, use wood-species base price. See front cover for details.*
- **Custom decorative laminate doors**  
*Contact office for quotation.*
- **Keylock 1 side** (Weiser or Schlage cylinder) ..... \$30
- **Keylock 1 side** (Best cylinder pull w core) ..... \$120  
*Deadlatch with thumb turn one side, keylock one side.*
- **Keylock 2 sides** (Weiser or Schlage cylinder) ..... \$60
- **Keylock 2 sides** (Best cylinder pull w core) ..... \$240  
*Deadlatch with keylock two sides.*
- **Non-locking foot-bolt** ..... \$36
- **Pull rod** ..... \$30
- **2-piece aluminum ceiling guard and track** (Priced per lineal foot) ..... \$20
- **Sliding jamb** ..... \$150
- **Double end lead post** ..... \$136
- **Intermediate rolling post** ..... \$100  
*For sectioning extra-wide room dividers, providing a surface for attaching foot-bolt.*
- **Fire-retardancy** ..... add 30%  
*Panels with Class 1 fire-retardant core. Available in light oak and chalk vinyl-lam only.*



# Woodfold Creative Decorative Options

Made to fit your opening sizes  
Continuous pin-hinge hardware  
top and bottom, heavy-duty track

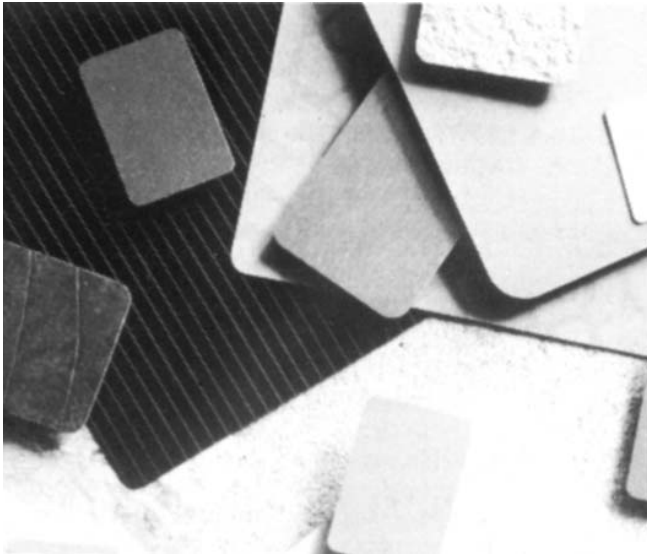

## Custom Decorative Laminate Panels

**A Special Suggestion:** When *solid color* laminates are specified, we suggest providing an alternate quotation using our easy-clean durable custom-paint finish.

**A Woodfold Custom Service:** Applying specified decorative laminates to door panels. For quotation, please advise pattern number and manufacturer such as:



## Display and Sample Kits—Customized Samples Are Also Available



Vinyl Swatch Card—\$2.50



Hardwood Swatch Card—\$2.50



Color Chip Set—\$8



Series 140—\$40



Series 220—\$40



Series 440—\$40



Series 540—\$40



Series 2100—\$40

**Freight  
Prepaid** 



Series 240—\$100



Series 640/740—\$100



Series 3300—\$150

### WOODFOLD MFG., INC.

PO Box 346  
Forest Grove, Oregon 97116  
P: 503.357.7181  
F: 503.357.7185  
woodfold@woodfold.com  
woodfold.com

Distributed by: